



CITY COUNCIL MEETING AGENDA

November 1, 2018

Marc D. Tall, Mayor
Ronald J. Beauchamp, Mayor Pro Tem
Ralph B. Blasier, Council Member
Michael R. Sattem, Council Member
Peggy O. Schumann, Council Member

Patrick S. Jordan, City Manager
Tammy A. Weissert, Interim City Clerk
Ralph B. K. Peterson, City Attorney

City Council Chambers located at: City Hall – 410 Ludington Street – Room C101 – Escanaba MI 49829

The Council has adopted a policy to use a Consent Agenda, when appropriate. All items with an asterisk (*) are considered routine by the City Council and will be enacted by one motion. There will be no separate discussion of these items unless a Council Member or citizen so requests, in which event, the item will be removed from the General Order of Business and considered in its normal sequence on the Agenda.

Regular Meeting

Thursday, November 1, 2018, at 7:00 p.m.

CALL TO ORDER

ROLL CALL

INVOCATION/PLEDGE OF ALLEGIANCE

APPROVAL/CORRECTION(S) TO MINUTES – Regular Meeting – October 18, 2018

APPROVAL/ADJUSTMENTS TO THE AGENDA

CONFLICT OF INTEREST DECLARATION(S)

BRIEF PUBLIC COMMENT(S)

PUBLIC HEARINGS

1. Public Hearing - Setting USDA Grant Application Public Hearing – November 1, 2018 – Public Safety.

Explanation: Administration is recommending approval of a USDA Grant for a 65%/35% funding split for a new command vehicle for Public Safety. Total cost is \$50,865 with the City covering \$33,065 and the USDA covering \$17,880.

2. Resolution Approval – Obsolete Property Rehabilitation Act (OPRA) – Exemption – District No. 25 – 301 North Lincoln Road.

Explanation: Dial Escanaba Mall I LLP, owner of 301 North Lincoln Road, has requested to be enrolled in the Obsolete Properties Rehabilitation Act (OPRA) (PA 146, 2000) which allows for partial exemption of property taxes for a specified period of time so that certain types of property improvements can be made. The intent of the legislation is to encourage rehabilitation of underutilized or decaying commercial or commercial/residential properties in certain designated communities. Administration is recommending an OPRA exemption up to twelve (12) years beginning December 31, 2018, and ending December 31, 2030.

3. Public Hearing – Resolution - CDBG/RLF Funding for Northern Machining & Repair – Treasurer.

Explanation: Administration is recommending approval of a loan of \$100,000 of CDBG/RLF program funds to Northern Machining & Repair, Inc. to assist with its equipment needs. This will result in the hiring of (5) new employees, 51% of whom have been previously classified as low to moderate income persons. No individuals will be displaced as a result of the proposed activities. Administration is recommending Council approval.

UNFINISHED BUSINESS - None

NEW BUSINESS

1. Approval - Lease agreement for Ness Field PI Tower Development communications Tower.

Explanation: Administration recommends approval of a Ground Lease Agreement with PI Tower Development, LLC for real property at Ness Field for the construction of the utility/equipment shed necessary for support of the communications tower to be constructed. This lease will be nullified if construction of Tower Facilities does not commence for any reason or no reason at all.

Agenda -- November 1, 2018

APPOINTMENTS
BOARD, COMMISSION, AND COMMITTEE REPORTS
GENERAL PUBLIC COMMENT
ANNOUNCEMENTS
ADJOURNMENT

Respectfully Submitted

A handwritten signature in black ink, appearing to read "Patrick S. Jordan". The signature is fluid and cursive, with the first name being the most prominent.

Patrick S. Jordan
City Manager

**OFFICIAL PROCEEDINGS
CITY COUNCIL
CITY OF ESCANABA, MICHIGAN
Regular Council Meeting
Thursday, October 18, 2018**

The meeting was called to order by the Honorable Mayor Marc D. Tall at 7:00 p.m. in the Council Chambers of City Hall located at 410 Ludington Street.

Present: Mayor Marc D. Tall, Council Members, Ronald J. Beauchamp, Ralph B. Blasier, Michael R. Sattem, and Peggy O'Connell Schumann.

Absent: None

Also Present: City Manager Patrick S. Jordan, City Department Heads, media, and members of the public.

Interim Clerk Weissert led Council in the Pledge of Allegiance.

Blasier moved, Sattem seconded, **CARRIED UNANIMOUSLY**, to approve Regular Meeting minutes from October 4, 2018, as submitted.

ADJUSTMENTS TO THE AGENDA

Beauchamp moved, Sattem seconded, **CARRIED UNANIMOUSLY**, to approve the Agenda as submitted.

CONFLICT OF INTEREST DECLARATION – None

BRIEF PUBLIC COMMENT

William Gasman, Escanaba resident, is concerned about the Delta Plaza Mall property. Mr. Gasman questions if it is in the best of our interest for the community to support.

PUBLIC HEARINGS – None

UNFINISHED BUSINESS – None

NEW BUSINESS

Setting USDA Grant Application Public Hearing – November 1, 2018 – Public Safety.

Administration recommended Council set a public hearing date for November 1, 2018.

NB-1 Blasier moved, Sattem seconded, **CARRIED UNANIMOUSLY**, set a public hearing date for November 1, 2018, for the USDA Grant Application.

Upon a call of the roll, the vote was as follows:

Ayes: Blasier, Sattem, Schumann, Beauchamp, Tall
Nays: None

MOTION CARRIED.

Approval – Historic District Commission Term Re-Alignment.

Administration sought approval to have the Historic District Commission terms be re-aligned to conform to the schedule outlined in the ordinance and based on the original appointment dates.

NB-2 Schumann moved, Beauchamp seconded, **CARRIED UNANIMOUSLY**, to approve to have the Historic District Commission terms be re-aligned to conform to the schedule outlined in the ordinance and based on the original appointment dates.

Approval – Pole Inspection/Treatment Bid – Electric Department.

Administration sought Council approval to retain Karcz Utility Services, LLC of Pulaski, WI, to do some pole testing, for an amount not to exceed \$15,000.

Electric Superintendent Mike Furmanski gave a brief overview on pole testing inspections.

NB-3 Schumann moved, Blasier seconded, to approve to retain Karcz Utility Services, LLC of Pulaski, WI, to do some pole testing, for an amount not to exceed \$15,000.

Upon a call of the roll, the vote was as follows:

Ayes: Schumann, Blaiser, Sattem, Beauchamp, Tall
Nays: None

MOTION CARRIED.

Approval – Swing Set Donation to the Learning Center – Recreation.

Administration sought approval for the donation of one set of swings be donated to the Learning Center. The Recreation Advisory Board at their October 9, 2018, meeting motioned unanimously to recommend City Council approval.

Recreation Director Kim Peterson gave a brief overview on the swing set donation to the Learning Center.

NB-4 Beauchamp moved, Sattem seconded, **CARRIED UNANIMOUSLY**, to approve of a donation of one set of swings be donated to the Learning Center as long as there is appropriate documentation stating the City is not responsible for any of the equipment in the future.

Upon a call of the roll, the vote was as follows:

Ayes: Beauchamp, Sattem, Blasier, Schumann, Tall
Nays: None

MOTION CARRIED.

Setting Obsolete Property Rehabilitation Exemption Public Hearing – November 1, 2018 – 301 North Lincoln Road – District No. 25.

Dial Escanaba Mall I LLP, owner of 301 North Lincoln Road, has requested to be enrolled in the Obsolete Properties Rehabilitation Act (OPRA) (PA 146, 2000) which allows for partial exemption of property taxes for a specified period of time so that certain types of property improvements can be made. The intent of the legislation is to encourage rehabilitation of underutilized or decaying commercial or commercial/residential properties in certain designated communities. Administration recommend Council set a public hearing date for November 1, 2018, so there is public understanding of the project.

NB-5 Blasier moved, Schumann seconded, **CARRIED UNANIMOUSLY**, to set a public hearing date for November 1, 2018, for the OPRA District No. 25 – 301 North Lincoln Road exemption so there is public understanding of the project.

Approval – Resolution - MERS Uniform 457 Supplemental Retirement Program Plan – Treasurer.

Administration sought approval of a resolution to open an additional 457 Plan through MERS.

City Treasurer Robert Valentine gave a brief over on the MERS Uniform 457 Supplemental Retirement Program Plan.

NB-6 Resolved by Council Member Schumann, seconded by Council Member Blasier;

MERS Uniform 457 Supplemental Retirement Program Resolution

This Resolution, together with the MERS 457 Supplemental Retirement Program and Trust Master Plan Document and the MERS 457 Supplemental Retirement Program

Participation Agreement and any Addendum thereto, constitute the entire MERS 457 Deferred Compensation Plan Document.

WHEREAS, the Municipal Employees Retirement Act of 1984, Section 36(2)(a), MCL 38.1536(2)(a) (MERS Plan Document (Section 36(2)(a)) authorizes the Municipal Employees' Retirement Board (the "Board") to "establish additional programs including but not limited to defined benefit, defined contribution, ancillary benefits, health and welfare benefits, and other postemployment benefit programs," and on November 8, 2011, the Municipal Employees' Retirement Board adopted the MERS 457 Deferred Compensation Plan.

WHEREAS, this Uniform Resolution has been approved by the Board under the authority of Section 36(2)(a), and the Board has authorized the MERS 457 Deferred Compensation Plan, which shall not be implemented unless in strict compliance with the terms and conditions of this Resolution.

WHEREAS, the Participating Employer, a participating "municipality" (as defined in Section 2b(2) in the Municipal Employees Retirement Act of 1984; MCL 38.1502b(2); Plan Document Section 2b(4)) or participating "court" (circuit, district or probate court as defined in Section 2a(4) – (6) of the Act, MCL 38.1502a(4) – (6); Plan Document Section 2a(4) – (6)) within the State of Michigan has determined that in the interest of attracting and retaining qualified employees, it wishes to offer a deferred compensation plan;

WHEREAS, the Participating Employer has also determined that it wishes to encourage employees' saving for retirement by offering salary reduction contributions;

WHEREAS, the Participating Employer has reviewed the MERS 457 Supplemental Retirement Program ("Plan");

WHEREAS, the Participating Employer wishes to participate in the Plan to provide certain benefits to its employees, reduce overall administrative costs, and afford attractive investment opportunities;

WHEREAS, the Participating Employer is an Employer as defined in the Plan;

WHEREAS, concurrent with this Resolution, and as a continuing obligation, this Governing Body has completed and approved, and submitted to MERS and the Board documents necessary for adoption and implementation of the Plan; and

WHEREAS, the Governing Body for and on behalf of the Participating Employer is authorized by law to adopt this Resolution approving the Participation Agreement on behalf of the Participating Employer. In the event any alteration of the terms or conditions stated in this Resolution is made or occurs, it is expressly recognized that MERS and the Retirement Board, as sole trustee and fiduciary of the Plan and its trust reserves, and whose authority is nondelegable, shall have no obligation or duty to continue to administer (or to have administered) the MERS 457 Supplemental Retirement Program for the Participating Employer.

NOW, THEREFORE, BE IT RESOLVED that the Governing Body adopts the MERS 457 Supplemental Retirement Program as provided below.

- I. The Participating Employer adopts the Plan for its Employees.
- II. The Participating Employer hereby adopts the terms of the Participation Agreement, which is attached hereto and made a part of this Resolution. The Participation Agreement sets forth the Employees to be covered by the Plan, the benefits to be provided by the Participating Employer under the Plan, and any conditions imposed by the Participating Employer with respect to, but not inconsistent with, the Plan. The Participating Employer reserves the right to amend its elections under the Participation Agreement, so long as the amendment is not inconsistent with the Plan or the Internal Revenue Code or other applicable law and is approved by the Board.
- III. The Participating Employer shall abide by the terms of the Plan, including amendments to the Plan made by the Board, all investment, administrative, and other service agreements of the Plan and the Trust, and all applicable provisions of the Internal Revenue Code and other applicable law.
- IV. The Participating Employer acknowledges that the Board is only responsible for the Plan and any other plans of the Employer administered by MERS and that the Board has no responsibility for other employee benefit plans maintained by the Employer that are not part of MERS.
- V. The Participating Employer accepts the administrative services to be provided by MERS and any services provided by a Service Manager as delegated by the Board. The Participating Employer acknowledges that fees will be imposed with respect to the services provided and that such fees may be deducted from the Participants' accounts.
- VI. The Participating Employer acknowledges that the Plan contains provisions for involuntary Plan termination.
- VII. The Participating Employer acknowledges that all assets held in connection with the Plan, including all contributions to the Plan, all property and rights acquired or purchased with such amounts and all income attributable to such amounts, property or rights shall be held in trust for the exclusive benefit of Participants and their Beneficiaries under the Plan. No part of the assets and income of the Plan shall be used for, or diverted to, purposes other than for the exclusive benefit of Participants and their Beneficiaries and for defraying reasonable expenses of the Plan. All amounts of compensation deferred pursuant to the Plan, all property and rights acquired or purchased with such amounts and all income attributable to such amounts, property or rights held as part of the Plan, shall be transferred to the Board to be held, managed, invested and distributed as part of the Trust Fund in accordance with the provisions of the Plan. All contributions to the Plan must be transferred by the Participating Employer to the Trust Fund. All benefits under the Plan shall be distributed solely from the Trust

Fund pursuant to the Plan.

- VIII. This Resolution and the Participation Agreement shall be submitted to the Board for its approval. The Board shall determine whether the Resolution complies with the Plan, and, if it does, shall provide appropriate forms to the Participating Employer to implement participation in the Plan. The Board may refuse to approve a Participation Agreement by an Employer that does not possess State statutory authority to participate in the Plan. The Governing Body hereby acknowledges that it is responsible to assure that this Resolution and the Participation Agreement are adopted and executed in accordance with the requirements of applicable law.

BE IT FINALLY RESOLVED: This Resolution shall have no legal effect under the Plan until a certified copy of this adopting Resolution is filed with MERS, and MERS determines that all necessary requirements under the 457 Supplemental Retirement Program Plan and Trust, the Participation Agreement, and this Resolution have been met. All dates for implementation of the Plan shall be determined by MERS from the date of filing with MERS of this Resolution in proper form and content. Upon MERS determination that all necessary documents have been submitted to MERS, MERS shall record its formal approval upon this Resolution, and return a copy to the Employer.

Ayes: Schumann, Blasier, Sattlem, Beauchamp, Tall
Nays: None

RESOLUTION DECLARED ADOPTED.

Discussion/Update – United Impact Group, LLC FOIA.

Heard legal counsel opinion on destruction date.

City Attorney Ralph B.K. Peterson stated the 2016 Election ballots could legally be destroyed but advised that the city retain the ballots for another six months. Mr. Peterson also advised the citizens to have no fear that there is no way that any of these ballots can be matched up with the voter. Mr. Peterson stated there was no cost for the city to retain the ballots and it would show the City of Escanaba was transparent and had no hidden agenda if a future FOIA request was made. Also, the city was advised by the Michigan Attorney General and the Michigan Municipal League to keep the ballots for another six months.

NB-7 Blasier moved, Schumann seconded, to approve to destroy the 2016 Election ballots on October 19, 2018, the day after the Council Meeting.

Upon a call of the roll, the vote was as follows:

Ayes: Blasier, Tall
Nays: Schumann, Sattlem, Beauchamp

MOTION FAILED.

Setting a Public Hearing for CDBG RLF Program for Northern Machining & Repair, Inc. – November 1, 2018 – Treasurer.

Administration recommended Council set a public hearing date for November 1, 2018.

NB-8 Blasier moved, Sattem seconded, to set a public hearing date for November 1, 2018, for the CDBG RLF Program for Northern Machining & Repair, Inc.

The vote was as follows:

Ayes: Blasier, Sattem, Schumann, Beauchamp, Tall

Nays: None

MOTION CARRIED.

Brownfield Redevelopment 381 Plan – 301 North Lincoln Road, Escanaba, Michigan.

Council was requested to amend the City of Escanaba's Brownfield Redevelopment Act 381 Plan by including the Brownfield Redevelopment 381 Plan for property located at 301 North Lincoln Road, Escanaba, Michigan. The plan includes eligible activities, costs and estimated tax capture for reimbursement of eligible expenses under Public Act 381, of the Brownfield Redevelopment Financing Act. On October 17, 2018, the Escanaba Brownfield Redevelopment Authority conducted a public hearing and has recommended Council approval.

Myron Berry gave a brief overview on the Brownfield Redevelopment 381 Plan located at 301 North Lincoln Road.

NB-9 Resolved by Council Member Blasier, seconded by Council Member Schumann;

**Resolution by the Escanaba City Council
Approving a Brownfield Plan**

Delta Plaza Mall and Outlots Brownfield Plan

**Pursuant to and in accordance with the provisions of Act 381
of the Public Acts of the State of Michigan 1996, as amended**

WHEREAS, the City of Escanaba Brownfield Redevelopment Authority ("Authority"), pursuant to and in accordance with the provisions of the Brownfield Redevelopment Financing Act, Act 381 of the Public Acts of the State of Michigan of 1996, as amended, has prepared a Brownfield Plan for Delta Plaza and Outlots ("Plan"), pursuant to and in accordance with Section 13 of the Act; and,

WHEREAS, the Authority conducted a Public Hearing pursuant to Section 14 of the Plan with proper notice given to the public and to taxing jurisdictions that levy taxes subject to capture as a result of this Plan; and,

WHEREAS, the Authority has recommended for approval by the Escanaba City Council the Brownfield Plan for Delta Plaza Mall and Outlots; and,

WHEREAS, as a result of its review of the Plan, the City Council desires to proceed with approval of the Plan;

NOW THEREFORE, BE IT RESOLVED THAT:

1. **FINDINGS.** The City Council makes the following determinations and findings:
 - A. The Plan constitutes a public purpose under the Act;
 - B. The Plan meets all of the requirements for a Brownfield Plan set forth in Sections 13 and 13b of the Act;
 - C. The proposed method of financing the costs of eligible activities by Dial Escanaba Mall LLP as described in the Plan is feasible.
 - D. The costs of the eligible activities proposed in the Plan are reasonable and necessary to carry out the purposes of the act; and,
 - E. The amount of captured taxable value estimated to result from adoption of the Plan is reasonable.

2. **PLAN APPROVED.** Pursuant to the authority vested in the Authority by the Act, and pursuant to and in accordance with the provisions of Section 14 of the Act, the Act 381 Combined Brownfield Plan for Delta Plaza Mall and Outlots dated September 18, 2018 is approved for a period of 30 years beginning 2019 and adopts the Act 381 Combined Brownfield Plan for Delta Plaza Mall and Outlots as Site 19 in the City of Escanaba Brownfield Plan.

The vote was as follows:

Ayes: Blasier, Schumann, Sattem, Beauchamp, Tall
Nays: None

RESOLUTION DECLARED ADOPTED.

APPOINTMENT(S) TO CITY BOARDS, COMMISSIONS, AND COMMITTEES – None

BOARD, COMMISSION, AND COMMITTEE REPORTS

Council Members reviewed City Board and Commission meetings each attended since the last City Council Meeting.

GENERAL PUBLIC COMMENT

Bonnie Heikkla, Escanaba resident, filed a Freedom of Information Act (FOIA) requesting emails and other documents related to the proposal. She went on to state City Code Official, Blaine DeGrave, who serves as the Administrative Liaison on the Board of Appeals, had stated he had not received the letter from Delta County Airport Manager TJ Reid opposing the tower. Ms. Heikkla believes there was lack of transparency.

Manager Jordan stated earlier in the project he had been in contact with TJ Reid, but does not remember receiving the letter.

There was discussion regarding once a decision is made by the Board of Appeals, the decision is final, but may appeal to the Delta County Circuit Court.

Dan Phalen, Escanaba resident, stated by allowing this cell phone tower the city is putting his life and everybody in the neighborhood at risk.

Schumann moved Tall seconded, approved a request to have the Board of Appeals review and relook at the decision with the additional information that has been brought to Council's attention.

The vote was as follows:

Ayes: Schumann, Tall, Beauchamp

Nays: Sattem

Abstain: Blasier

MOTION CARRIED.

William Gasman, Escanaba resident, expressed his concerns again regarding the Delta Plaza Mall property.

ANNOUNCEMENTS

- Annual Delta Animal Shelter Fundraiser will be held at the Island Resort & Casino;
- Trunk or Treat, will be held Saturday, October 27, 2018, 2:00 p.m. to 4:00 p.m., and are also looking for sponsors;
- Black Friday will be held Tuesday, November 20, 2018.

Hearing no further public comment, the Council adjourned at 8:10 p.m.

Respectfully submitted

Tammy A. Weissert, CMC
Interim City Clerk

Approved: _____

Marc D. Tall, Mayor

10/05/2018

The Department of Escanaba Public Safety is requesting the USDA grant funds of \$17,800.00 for an emergency response vehicle. The emergency response vehicle will be used for multiple types of emergency responses as we are a Public Safety department doing both police and fire protection. The vehicle will be used on varying types of emergency/critical incident situations such as motor vehicle rescue, hazmat, fire and police.

The vehicle will be used as an incident command center on police, fire, hazmat and motor vehicle rescue critical incidents. The response could be for "manmade" type incidents or an "act of God" type incident.

The vehicle will enable emergency response when there are severe weather conditions such as deep heavy snow and icy roads. The vehicle will also be used on emergency incidents in the rural areas we respond to that will require 4 wheel drive capabilities. Incidents we respond to in our rural areas are sometimes roads that are not maintained by the state or county. We have camps and residences that could require a 4 wheel drive type vehicle to get to them due to the road and/or weather conditions.

The emergency response vehicle will be acting as the supervisor vehicle. The emergency vehicle will or could be used to transport "tools" for police, hazmat, motor vehicle rescue and fire critical incidents that are not transported in our everyday patrol vehicles due to the limited amount of room or because we only have one of the "tools" and it will be available from the supervisor vehicle.

Thank you,



Patrick Jordan

City Manager, City of Escanaba

Mission Statement:



Enhancing the enjoyment and livability of our community by providing quality municipal services to our citizens.
The City of Escanaba is an equal opportunity employer and provider.

**APPLICATION FOR
FEDERAL ASSISTANCE**

Version 7/03

1. TYPE OF SUBMISSION: Application <input type="checkbox"/> Construction <input checked="" type="checkbox"/> Non-Construction		2. DATE SUBMITTED	Applicant Identifier
Pre-application: <input type="checkbox"/> Construction <input type="checkbox"/> Non-Construction		3. DATE RECEIVED BY STATE	State Application Identifier
		4. DATE RECEIVED BY FEDERAL AGENCY	Federal Identifier
5. APPLICANT INFORMATION			
Legal Name: City of Escanaba		Organizational Unit: Department: Escanaba Department of Public Safety	
Organizational DUNS: 086183043		Division: Police/Fire	
Address: Street: 410 Ludington St		Name and telephone number of person to be contacted on matters involving this application (give area code) Prefix: Mr.	
City: Escanaba		First Name: John	
County: Delta		Middle Name: Francis	
State: MI		Last Name: Gudwer	
Zip Code: 49829		Suffix: Jr	
Country: United States		Email: jgudwer@escanaba.org	
6. EMPLOYER IDENTIFICATION NUMBER (EIN): 38-6004679		Phone Number (give area code) 906-786-5911	
		Fax Number (give area code) 906-786-6030	
8. TYPE OF APPLICATION: <input checked="" type="checkbox"/> New <input type="checkbox"/> Continuation <input type="checkbox"/> Revision If Revision, enter appropriate letter(s) in box(es) (See back of form for description of letters.) Other (specify) <input type="checkbox"/> <input type="checkbox"/>		7. TYPE OF APPLICANT: (See back of form for Application Types) Municipal Other (specify)	
10. CATALOG OF FEDERAL DOMESTIC ASSISTANCE NUMBER: 10-766		9. NAME OF FEDERAL AGENCY: USDA Rural Development	
TITLE (Name of Program): Community Facilities Loan & Grant program		11. DESCRIPTIVE TITLE OF APPLICANT'S PROJECT: 2018 Ford F-150 WITH EQUIPMENT	
12. AREAS AFFECTED BY PROJECT (Cities, Counties, States, etc.): City of Escanaba and Wells Township			
13. PROPOSED PROJECT Start Date: Ending Date:		14. CONGRESSIONAL DISTRICTS OF: a. Applicant 1 b. Project 1	
15. ESTIMATED FUNDING:		16. IS APPLICATION SUBJECT TO REVIEW BY STATE EXECUTIVE ORDER 12372 PROCESS?	
a. Federal	\$ 17,800.00	a. Yes. <input checked="" type="checkbox"/> THIS PREAPPLICATION/APPLICATION WAS MADE AVAILABLE TO THE STATE EXECUTIVE ORDER 12372 PROCESS FOR REVIEW ON	
b. Applicant	\$ 33,066.00	DATE:	
c. State	\$.00	b. No. <input type="checkbox"/> PROGRAM IS NOT COVERED BY E. O. 12372	
d. Local	\$.00	<input type="checkbox"/> OR PROGRAM HAS NOT BEEN SELECTED BY STATE FOR REVIEW	
e. Other	\$.00	17. IS THE APPLICANT DELINQUENT ON ANY FEDERAL DEBT?	
f. Program Income	\$.00	<input type="checkbox"/> Yes If "Yes" attach an explanation. <input checked="" type="checkbox"/> No	
g. TOTAL	\$ 50,866.00		
18. TO THE BEST OF MY KNOWLEDGE AND BELIEF, ALL DATA IN THIS APPLICATION/PREAPPLICATION ARE TRUE AND CORRECT. THE DOCUMENT HAS BEEN DULY AUTHORIZED BY THE GOVERNING BODY OF THE APPLICANT AND THE APPLICANT WILL COMPLY WITH THE ATTACHED ASSURANCES IF THE ASSISTANCE IS AWARDED.			
a. Authorized Representative			
Prefix Mr.	First Name Patrick	Middle Name Sean	
Last Name Jordan		Suffix	
b. Title City Manager		c. Telephone Number (give area code) 906-786-9402	
d. Signature of Authorized Representative <i>Patrick Jordan</i>		e. Date Signed 10/5/2018	

INSTRUCTIONS FOR THE SF-424

Public reporting burden for this collection of information is estimated to average 45 minutes per response, including time for reviewing instructions, searching existing data sources, gathering and maintaining the data needed, and completing and reviewing the collection of information. Send comments regarding the burden estimate or any other aspect of this collection of information, including suggestions for reducing this burden, to the Office of Management and Budget, Paperwork Reduction Project (0348-0043), Washington, DC 20503.

PLEASE DO NOT RETURN YOUR COMPLETED FORM TO THE OFFICE OF MANAGEMENT AND BUDGET. SEND IT TO THE ADDRESS PROVIDED BY THE SPONSORING AGENCY.

This is a standard form used by applicants as a required face sheet for pre-applications and applications submitted for Federal assistance. It will be used by Federal agencies to obtain applicant certification that States which have established a review and comment procedure in response to Executive Order 12372 and have selected the program to be included in their process, have been given an opportunity to review the applicant's submission.

Item:	Entry:	Item:	Entry:																
1.	Select Type of Submission.	11.	Enter a brief descriptive title of the project. If more than one program is involved, you should append an explanation on a separate sheet. If appropriate (e.g., construction or real property projects), attach a map showing project location. For preapplications, use a separate sheet to provide a summary description of this project.																
2.	Date application submitted to Federal agency (or State if applicable) and applicant's control number (if applicable).	12.	List only the largest political entities affected (e.g., State, counties, cities).																
3.	State use only (if applicable).	13.	Enter the proposed start date and end date of the project.																
4.	Enter Date Received by Federal Agency Federal Identifier number: If this application is a continuation or revision to an existing award, enter the present Federal Identifier number. If for a new project, leave blank.	14.	List the applicant's Congressional District and any District(s) affected by the program or project																
5.	Enter legal name of applicant, name of primary organizational unit (including division, if applicable), which will undertake the assistance activity, enter the organization's DUNS number (received from Dun and Bradstreet), enter the complete address of the applicant (including country); and name, telephone number, e-mail and fax of the person to contact on matters related to this application.	15.	Amount requested or to be contributed during the first funding/budget period by each contributor. Value of in kind contributions should be included on appropriate lines as applicable. If the action will result in a dollar change to an existing award, indicate only the amount of the change. For decreases, enclose the amounts in parentheses. If both basic and supplemental amounts are included, show breakdown on an attached sheet. For multiple program funding, use totals and show breakdown using same categories as item 15.																
6.	Enter Employer Identification Number (EIN) as assigned by the Internal Revenue Service.	16.	Applicants should contact the State Single Point of Contact (SPOC) for Federal Executive Order 12372 to determine whether the application is subject to the State Intergovernmental review process.																
7.	Select the appropriate letter in the space provided. <table style="width: 100%; border: none;"> <tr> <td style="width: 50%;">A. State</td> <td style="width: 50%;">I. State Controlled Institution of Higher Learning</td> </tr> <tr> <td>B. County</td> <td>J. Private University</td> </tr> <tr> <td>C. Municipal</td> <td>K. Indian Tribe</td> </tr> <tr> <td>D. Township</td> <td>L. Individual</td> </tr> <tr> <td>E. Interstate</td> <td>M. Profit Organization</td> </tr> <tr> <td>F. Intermunicipal</td> <td>N. Other (Specify)</td> </tr> <tr> <td>G. Special District</td> <td>O. Not for Profit Organization</td> </tr> <tr> <td>H. Independent School District</td> <td></td> </tr> </table>	A. State	I. State Controlled Institution of Higher Learning	B. County	J. Private University	C. Municipal	K. Indian Tribe	D. Township	L. Individual	E. Interstate	M. Profit Organization	F. Intermunicipal	N. Other (Specify)	G. Special District	O. Not for Profit Organization	H. Independent School District		17.	This question applies to the applicant organization, not the person who signs as the authorized representative. Categories of debt include delinquent audit disallowances, loans and taxes.
A. State	I. State Controlled Institution of Higher Learning																		
B. County	J. Private University																		
C. Municipal	K. Indian Tribe																		
D. Township	L. Individual																		
E. Interstate	M. Profit Organization																		
F. Intermunicipal	N. Other (Specify)																		
G. Special District	O. Not for Profit Organization																		
H. Independent School District																			
8.	Select the type from the following list: <ul style="list-style-type: none"> • "New" means a new assistance award. • "Continuation" means an extension for an additional funding/budget period for a project with a projected completion date. • "Revision" means any change in the Federal Government's financial obligation or contingent liability from an existing obligation. If a revision enter the appropriate letter: <table style="width: 100%; border: none;"> <tr> <td style="width: 50%;">A. Increase Award</td> <td style="width: 50%;">B. Decrease Award</td> </tr> <tr> <td>C. Increase Duration</td> <td>D. Decrease Duration</td> </tr> </table> 	A. Increase Award	B. Decrease Award	C. Increase Duration	D. Decrease Duration	18.	To be signed by the authorized representative of the applicant. A copy of the governing body's authorization for you to sign this application as official representative must be on file in the applicant's office. (Certain Federal agencies may require that this authorization be submitted as part of the application.)												
A. Increase Award	B. Decrease Award																		
C. Increase Duration	D. Decrease Duration																		
9.	Name of Federal agency from which assistance is being requested with this application.																		
10.	Use the Catalog of Federal Domestic Assistance number and title of the program under which assistance is requested.																		

BUDGET INFORMATION - Non-Construction Programs

OMB Approval No. 0346-0044

SECTION A - BUDGET SUMMARY						
Grant Program Function or Activity (a)	Catalog of Federal Domestic Assistance Number (b)	Estimated Unobligated Funds		New or Revised Budget		
		Federal (c)	Non-Federal (d)	Federal (e)	Non-Federal (f)	Total (g)
1.		\$	\$	\$	\$	\$ 0.00
2.						0.00
3.						0.00
4.						0.00
5. Totals		\$ 0.00	\$ 0.00	\$ 0.00	\$ 0.00	\$ 0.00
SECTION B - BUDGET CATEGORIES						
6. Object Class Categories	GRANT PROGRAM, FUNCTION OR ACTIVITY				Total (5)	
	(1)	(2)	(3)	(4)		
a. Personnel	\$	\$	\$	\$	\$ 0.00	
b. Fringe Benefits					0.00	
c. Travel					0.00	
d. Equipment					0.00	
e. Supplies					0.00	
f. Contractual					0.00	
g. Construction					0.00	
h. Other					0.00	
i. Total Direct Charges (sum of 6a-6h)		0.00	0.00	0.00	0.00	
j. Indirect Charges					0.00	
k. TOTALS (sum of 6i and 6j)	\$	\$ 0.00	\$ 0.00	\$ 0.00	\$ 0.00	
7. Program Income	\$	\$	\$	\$	\$ 0.00	

SECTION C - NON-FEDERAL RESOURCES					
(a) Grant Program	(b) Applicant	(c) State	(d) Other Sources	(e) TOTALS	
8.	\$	\$	\$	\$ 0.00	
9.				0.00	
10.				0.00	
11.				0.00	
12. TOTAL (sum of lines 8- 11)	\$ 0.00	\$ 0.00	\$ 0.00	\$ 0.00	
SECTION D - FORECASTED CASH NEEDS					
	Total for 1st Year	1st Quarter	2nd Quarter	3rd Quarter	4th Quarter
13. Federal	\$ 0.00	\$	\$	\$	\$
14. Non-Federal	0.00				
15. TOTAL (sum of lines 13 and 14)	\$ 0.00	\$ 0.00	\$ 0.00	\$ 0.00	\$ 0.00
SECTION E - BUDGET ESTIMATES OF FEDERAL FUNDS NEEDED FOR BALANCE OF THE PROJECT					
(a) Grant Program	FUTURE FUNDING PERIODS (Years)				
	(b) First	(c) Second	(d) Third	(e) Fourth	
16.	\$	\$	\$	\$	
17.					
18.					
19.					
20. TOTAL (sum of lines 16-19)	\$ 0.00	\$ 0.00	\$ 0.00	\$ 0.00	
SECTION F - OTHER BUDGET INFORMATION					
21. Direct Charges:		22. Indirect Charges:			
23. Remarks:					

ASSURANCES - NON-CONSTRUCTION PROGRAMS

Public reporting burden for this collection of information is estimated to average 15 minutes per response, including time for reviewing instructions, searching existing data sources, gathering and maintaining the data needed, and completing and reviewing the collection of information. Send comments regarding the burden estimate or any other aspect of this collection of information, including suggestions for reducing this burden, to the Office of Management and Budget, Paperwork Reduction Project (0348-0040), Washington, DC 20503.

PLEASE DO NOT RETURN YOUR COMPLETED FORM TO THE OFFICE OF MANAGEMENT AND BUDGET. SEND IT TO THE ADDRESS PROVIDED BY THE SPONSORING AGENCY.

NOTE: Certain of these assurances may not be applicable to your project or program. If you have questions, please contact the awarding agency. Further, certain Federal awarding agencies may require applicants to certify to additional assurances. If such is the case, you will be notified.

As the duly authorized representative of the applicant, I certify that the applicant:

1. Has the legal authority to apply for Federal assistance and the institutional, managerial and financial capability (including funds sufficient to pay the non-Federal share of project cost) to ensure proper planning, management and completion of the project described in this application.
2. Will give the awarding agency, the Comptroller General of the United States and, if appropriate, the State, through any authorized representative, access to and the right to examine all records, books, papers, or documents related to the award; and will establish a proper accounting system in accordance with generally accepted accounting standards or agency directives.
3. Will establish safeguards to prohibit employees from using their positions for a purpose that constitutes or presents the appearance of personal or organizational conflict of interest, or personal gain.
4. Will initiate and complete the work within the applicable time frame after receipt of approval of the awarding agency.
5. Will comply with the Intergovernmental Personnel Act of 1970 (42 U.S.C. §§4728-4763) relating to prescribed standards for merit systems for programs funded under one of the 19 statutes or regulations specified in Appendix A of OPM's Standards for a Merit System of Personnel Administration (5 C.F.R. 900, Subpart F).
6. Will comply with all Federal statutes relating to nondiscrimination. These include but are not limited to: (a) Title VI of the Civil Rights Act of 1964 (P.L. 88-352) which prohibits discrimination on the basis of race, color or national origin; (b) Title IX of the Education Amendments of 1972, as amended (20 U.S.C. §§1681- 1683, and 1686-1686), which prohibits discrimination on the basis of sex; (c) Section 504 of the Rehabilitation Act of 1973, as amended (29 U.S.C. §794), which prohibits discrimination on the basis of handicaps; (d) the Age Discrimination Act of 1975, as amended (42 U.S.C. §§6101-6107), which prohibits discrimination on the basis of age; (e) the Drug Abuse Office and Treatment Act of 1972 (P.L. 92-255), as amended, relating to nondiscrimination on the basis of drug abuse; (f) the Comprehensive Alcohol Abuse and Alcoholism Prevention, Treatment and Rehabilitation Act of 1970 (P.L. 91-616), as amended, relating to nondiscrimination on the basis of alcohol abuse or alcoholism; (g) §§523 and 527 of the Public Health Service Act of 1912 (42 U.S.C. §§290 dd-3 and 290 ee 3), as amended, relating to confidentiality of alcohol and drug abuse patient records; (h) Title VIII of the Civil Rights Act of 1968 (42 U.S.C. §§3601 et seq.), as amended, relating to nondiscrimination in the sale, rental or financing of housing; (i) any other nondiscrimination provisions in the specific statute(s) under which application for Federal assistance is being made; and, (j) the requirements of any other nondiscrimination statute(s) which may apply to the application.
7. Will comply, or has already complied, with the requirements of Titles II and III of the Uniform Relocation Assistance and Real Property Acquisition Policies Act of 1970 (P.L. 91-646) which provide for fair and equitable treatment of persons displaced or whose property is acquired as a result of Federal or federally-assisted programs. These requirements apply to all interests in real property acquired for project purposes regardless of Federal participation in purchases.
8. Will comply, as applicable, with provisions of the Hatch Act (5 U.S.C. §§1501-1508 and 7324-7328) which limit the political activities of employees whose principal employment activities are funded in whole or in part with Federal funds.

9. Will comply, as applicable, with the provisions of the Davis-Bacon Act (40 U.S.C. §§276a to 276a-7), the Copeland Act (40 U.S.C. §276c and 18 U.S.C. §874), and the Contract Work Hours and Safety Standards Act (40 U.S.C. §§327-333), regarding labor standards for federally-assisted construction subagreements.
10. Will comply, if applicable, with flood insurance purchase requirements of Section 102(a) of the Flood Disaster Protection Act of 1973 (P.L. 93-234) which requires recipients in a special flood hazard area to participate in the program and to purchase flood insurance if the total cost of insurable construction and acquisition is \$10,000 or more.
11. Will comply with environmental standards which may be prescribed pursuant to the following: (a) institution of environmental quality control measures under the National Environmental Policy Act of 1969 (P.L. 91-190) and Executive Order (EO) 11514; (b) notification of violating facilities pursuant to EO 11738; (c) protection of wetlands pursuant to EO 11990; (d) evaluation of flood hazards in floodplains in accordance with EO 11988; (e) assurance of project consistency with the approved State management program developed under the Coastal Zone Management Act of 1972 (16 U.S.C. §§1451 et seq.); (f) conformity of Federal actions to State (Clean Air) Implementation Plans under Section 176(c) of the Clean Air Act of 1955, as amended (42 U.S.C. §§7401 et seq.); (g) protection of underground sources of drinking water under the Safe Drinking Water Act of 1974, as amended (P.L. 93-523); and, (h) protection of endangered species under the Endangered Species Act of 1973, as amended (P.L. 93-205).
12. Will comply with the Wild and Scenic Rivers Act of 1968 (16 U.S.C. §§1271 et seq.) related to protecting components or potential components of the national wild and scenic rivers system.
13. Will assist the awarding agency in assuring compliance with Section 106 of the National Historic Preservation Act of 1966, as amended (16 U.S.C. §470), EO 11593 (identification and protection of historic properties), and the Archaeological and Historic Preservation Act of 1974 (16 U.S.C. §§469a-1 et seq.).
14. Will comply with P.L. 93-348 regarding the protection of human subjects involved in research, development, and related activities supported by this award of assistance.
15. Will comply with the Laboratory Animal Welfare Act of 1966 (P.L. 89-544, as amended, 7 U.S.C. §§2131 et seq.) pertaining to the care, handling, and treatment of warm blooded animals held for research, teaching, or other activities supported by this award of assistance.
16. Will comply with the Lead-Based Paint Poisoning Prevention Act (42 U.S.C. §§4801 et seq.) which prohibits the use of lead-based paint in construction or rehabilitation of residence structures.
17. Will cause to be performed the required financial and compliance audits in accordance with the Single Audit Act Amendments of 1996 and OMB Circular No. A-133, "Audits of States, Local Governments, and Non-Profit Organizations."
18. Will comply with all applicable requirements of all other Federal laws, executive orders, regulations, and policies governing this program.

SIGNATURE OF AUTHORIZED CERTIFYING OFFICIAL <i>Ralph Jordan</i>	TITLE <i>City Manager</i>
APPLICANT ORGANIZATION <i>City of Escanaba</i>	DATE SUBMITTED <i>10/15/18</i>

EQUAL OPPORTUNITY AGREEMENT

This agreement, dated _____ between
The City of Escanaba

(herein called "Recipient" whether one or more) and United States Department of Agriculture (USDA), pursuant to the rules and regulations of the Secretary of Labor (herein called the "Secretary") issued under the authority of Executive Order 11246 as amended, witnesseth:

In consideration of financial assistance (whether by a loan, grant, loan guaranty, or other form of financial assistance) made or to be made by the USDA to Recipient, Recipient hereby agrees; if the cash cost of construction work performed by Recipient or a construction contract financed with such financial assistance exceeds \$10,000 - unless exempted by rules, regulations or orders of the Secretary of Labor issued pursuant to Section 204 of Executive Order 11246 of September 24, 1965.

1. To incorporate or cause to be incorporated into any contract for construction work, or modification thereof, subject to the relevant rules, regulations, and orders of the Secretary or of any prior authority that remain in effect, which is paid for in whole or in part with the aid of such financial assistance, the following "Equal Opportunity Clause":

During the performance of this contract, the contractor agrees as follows:

- (a) The contractor will not discriminate against any employee or applicant for employment because of race, color, religion, sex or national origin. The contractor will take affirmative action to ensure that applicants are employed, and that employees are treated during employment, without regard to their race, color, religion, sex or national origin. Such action shall include, but not be limited, to the following: employment, upgrading, demotion or transfer; recruitment or recruitment advertising; layoff or termination; rates of pay or other forms of compensation; and selection for training, including apprenticeship. The contractor agrees to post in conspicuous places, available to employees and applicants for employment, notices to be provided by the USDA setting forth the provisions of this nondiscrimination clause.
- (b) The contractor will, in all solicitations or advertisements for employees placed by or on behalf of the contractor, state that all qualified applicants will receive consideration for employment without regard to race, color, religion, sex or national origin.
- (c) The contractor will send to each labor union or representative of workers with which he has a collective bargaining agreement or other contract or understanding, a notice, to be provided by the USDA, advising the said labor union or workers' representative of the contractor's commitments under this agreement and shall post copies of the notice in conspicuous places available to employees and applicants for employment.
- (d) The contractor will comply with all provisions of Executive Order 11246 of September 24, 1965, and of all rules, regulations and relevant orders of the Secretary of Labor.
- (e) The contractor will furnish all information and reports required by Executive Order 11246 of September 24, 1965, rules, regulations, and orders, or pursuant thereto, and will permit access to his books, records, and accounts by the USDA Civil Rights Office, and the Secretary of Labor for purposes of investigation to ascertain compliance with such rules, regulations, and orders.
- (f) In the event of the contractor's noncompliance with the nondiscrimination clauses of this contract or with any of the said rules, regulations, or orders, this contract may be cancelled, terminated, or suspended in whole or in part and the contractor may be declared ineligible for further Government contracts or federally assisted construction contracts in accordance with procedures authorized in Executive Order No. 11246 of September 24, 1965, and such other sanctions may be imposed and remedies invoked as provided in Executive Order No. 11246 of September 24, 1965, or by rule, regulation or order of the Secretary of Labor, or as otherwise provided by Law.
- (g) The contractor will include the provisions of paragraph 1 and paragraph (a) through (g) in every subcontract or purchase order, unless exempted by the rules, regulations, or orders of the Secretary of Labor issued pursuant to Section 204 of Executive Order No. 11246 of September 24, 1965, so that such provisions will be binding upon each subcontractor or vendor. The contractor will take such action with respect to any subcontract or purchase order as the USDA may direct as a means of enforcing such provisions, including sanctions for noncompliance. Provided, however, that in the event the contractor becomes involved in, or is threatened with, litigation with a subcontractor or vendor as a result of such direction by the USDA, the contractor may request the United States to enter into such litigation to protect the interest of the United States.

According to the Paperwork Reduction Act of 1995, an agency may not conduct or sponsor, and a person is not required to respond to, a collection of information unless it displays a valid OMB control number. The valid OMB control number for this information collection is 0575-0018. The time required to complete this information collection is estimated to average 10 minutes per response, including the time for reviewing instructions, searching existing data sources, gathering and maintaining the data needed, and completing and reviewing the collection of information.

2. To be bound by the above equal opportunity clause with respect to its own employment practices when it participates in federally assisted construction work; Provided, that if the organization so participating is a State or local government, the above equal opportunity clause is not applicable to any agency, instrumentality or subdivision of such government which does not participate in work on or under the contract.
3. To notify all prospective contractors to file the required 'Compliance Statement', Form RD 400-6, with their bids.
4. Form AD-425, Instructions to Contractors, will accompany the notice of award of the contract. Bid conditions for all nonexempt federal and federally assisted construction contracts require inclusion of the appropriate "Hometown" or "Imposed" plan affirmative action and equal employment opportunity requirements. All bidders must comply with the bid conditions contained in the invitation to be considered responsible bidders and hence eligible for the award.
5. To assist and cooperate actively with USDA and the Secretary in obtaining the compliance of contractors and subcontractors with the equal opportunity clause and rules, regulations, and relevant orders of the Secretary, that will furnish USDA and the Secretary such information such as, but not limited to, Form AD-560, Certification of Nonsegregated Facilities, to submit the Monthly Employment Utilization Report, Form CC-257, as they may require for the supervision of such compliance, and that it will otherwise assist USDA in the discharge of USDA's primary responsibility for securing compliance.
6. To refrain from entering into any contract or contract modification subject to such Executive Order 11246 of September 24, 1965, with a contractor debarred from, or who has not demonstrated eligibility for, Government contracts and Federally assisted construction contracts pursuant to the Executive Order and will carry out such sanctions and penalties for violation of the equal opportunity clause as may be imposed upon contractors and subcontractors by USDA or the Secretary of Labor pursuant to Part II, Subpart D, of the Executive Order.
7. That if the recipient fails or refuses to comply with these undertakings, the USDA may take any or all of the following actions: Cancel, terminate, or suspend in whole or in part this grant (contract, loan, insurance, guarantee); refrain from extending any further assistance to the organization under the program with respect to which the failure or refund occurred until satisfactory assurance of future compliance has been received from such organization; and refer the case to the Department of Justice for appropriate legal proceedings.

Signed by the Recipient on the date first written above.

 City of Escanaba Recipient

Patrick Jordan

 Patrick Jordan, City Manager Recipient

(CORPORATE SEAL)

 Name of Corporate Recipient

Attest: *Larry A. Wessel*

 Secretary

By _____
 President

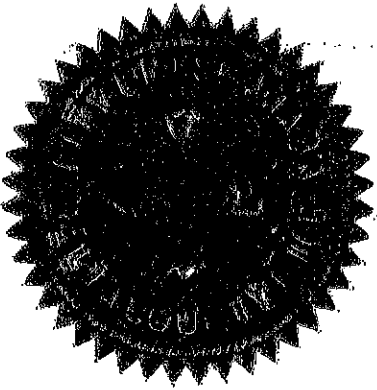



P.O. Box 948 • Escanaba, MI 49829-0948 • (906) 786-0240 • fax (906) 786-4755

TDD (800) 649-3777

CONTRIBUTION LETTER

The City of Escanaba is committed to and will be contributing \$33,065.00 towards the purchase of the new emergency response vehicle if granted the USDA grant funds of \$17,800 for the total project cost of \$50,865.00.

Thank you,

A handwritten signature in black ink, appearing to read "Pat H. Jordan". The signature is fluid and cursive, written over a horizontal line.

Mission Statement:



Enhancing the enjoyment and livability of our community by providing quality municipal services to our citizens.
The City of Escanaba is an equal opportunity employer and provider.

Escanaba

PUBLIC NOTICE

The Escanaba City Council will hold a public hearing to review the USDA Grant Application for funding for an emergency response vehicle. This meeting will be held in the City Council Chambers located at 410 Ludington Street, Escanaba, MI during the regularly scheduled Council Meeting on Thursday, November 1, 2018 at 7:00 p.m.

The City of Escanaba will provide necessary reasonable auxiliary aids and services, such as signers for the hearing impaired and audio tapes of printed materials being considered at the meeting, to individuals with disabilities at the meeting/hearing upon five (5) days notice to the City of Escanaba. Individuals with disabilities requiring auxiliary aids or services should contact the City of Escanaba Interim City Clerk Tammy A. Weissert in writing to 410 Ludington Street, Escanaba, MI 49829 or by calling (906) 786-1194.

P.H. - #2

CC. 11/1/18

Delta Plaza Mall
OPRE Application

In 2014, the City of Escanaba established an Obsolete Property Redevelopment District for the block including the Delta Plaza Mall. the Owner is now submitting this Application to gain the exemption for the Mall.

The following information is required as an attachment to the Obsolete Property Rehabilitation Exemption Application

A. General Description

The Mall was developed by Gamble Development Company and opened November 8, 1970. The Mall, a typical block and steel single story building, totals 127,787 square feet stores with limited outside entrance. At the present time 11 stores representing 51,727 square feet are occupied, leaving 76,000 square feet vacant.

B. Proposed Use after Rehabilitation

The Mall will continue to be used for retail sales. Marshalls has committed to developing a store within the Mall. The presence of this large national retailer should result in other tenants desiring to lease space, leading to further redevelopment.

C. Proposed Rehabilitation

The proposed rehabilitation includes the removing and construction of walls, reconstruction of store fronts, replacement of outdated features and moving utilities to create areas which will upgrade the current Mall to meet new tenant requirements.

A Mall where there is limited access from the outside is becoming a thing of the past. Consumers expect to be able to enter stores directly, and to generally have smaller stores.

E. Fixed Building Equipment

Upgrades to the Mall heating and cooling systems and utility modifications, beyond standard maintenance, will be reviewed as tenants are identified.

F. Schedule

The rehabilitation work is scheduled to begin in early 2019 and to be completed in three years.

G. Economic Advantages

The economic advantages which will result from the proposed rehabilitation are the revitalization of a large, mostly vacant, retail establishment within the City of Escanaba. Portions of the Mall have been vacant for periods of two to ten years. Through the rehabilitation efforts, the Mall can be the beginning of a trend to rehabilitate and regrow businesses in this area.

Further, other structures in this area are standing vacant. A revitalized mall can bring new life to the area, with new leases for these structures.

LEGAL DESCRIPTION FOR PROPERTY

DELTA PLAZA

The legal description for the Mall is as follows:

PART OF SEC 25 IN TOWNSHIP 39 N RANGE 23 W PRT OF BLOCKS 7, 8 & 9 OF THE CITY CENTER ADDITION NO. 3 & PRT OF SE1/4 OF NE1/4 BEG 502.33 FT N & 200 FT W OF E 1/4 COR OF SEC 25 TH N 89° 58' W 420.89 FT, TH N 0° 05' 39" E 100.5 FT, TH N 89° 58' W 82.5 FT, TH S 0° 05' 39" W 14.5 FT, TH N 89° 58' W 1.22 FT, TH N 89° 58' W 229.8 FT, TH N 0° 05' 39" E 366.06 FT TO S ROW OF 3RD AVE N, TH N 84° 51' 12" E 740.89 FT ALG ROW, TH S 0° 39' W 503.28 FT TO POB. 5.76 ACRES. (DESC CHANGED FOR 2017 AFTER SPLITS BY KD)

Application for Obsolete Property Rehabilitation Exemption Certificate

This form is issued as provided by Public Act 146 of 2000, as amended. This application should be filed after the district is established. This project will not receive tax benefits until approved by the State Tax Commission. Applications received after October 31 may not be acted upon in the current year. This application is subject to audit by the State Tax Commission.

INSTRUCTIONS: File the original and two copies of this form and the required attachments with the clerk of the local government unit. (The State Tax Commission requires two copies of the Application and attachments. The original is retained by the clerk.) Please see State Tax Commission Bulletin 9 of 2000 for more information about the Obsolete Property Rehabilitation Exemption. The following must be provided to the local government unit as attachments to this application: (a) General description of the obsolete facility (year built, original use, most recent use, number of stories, square footage); (b) General description of the proposed use of the rehabilitated facility, (c) Description of the general nature and extent of the rehabilitation to be undertaken, (d) A descriptive list of the fixed building equipment that will be a part of the rehabilitated facility, (e) A time schedule for undertaking and completing the rehabilitation of the facility, (f) A statement of the economic advantages expected from the exemption. A statement from the assessor of the local unit of government, describing the required obsolescence has been met for this building, is required with each application. Rehabilitation may commence after establishment of district.

Applicant (Company) Name (applicant must be the OWNER of the facility) Dial Escanaba Mall I LLP		
Company Mailing address (No. and street, P.O. Box, City, State, ZIP Code) 11506 Nicholas Street Suite 100, Omaha, NE, 68154		
Location of obsolete facility (No. and street, City, State, ZIP Code) 301 N Lincoln Road		
City, Township, Village (indicate which) City of Escanaba		County Delta
Date of Commencement of Rehabilitation (mm/dd/yyyy) 1-1-2019	Planned date of Completion of Rehabilitation (mm/dd/yyyy) 1-1-2022	School District where facility is located (include school code) Escanaba
Estimated Cost of Rehabilitation \$1,000,000.00	Number of years exemption requested 12	Attach Legal description of Obsolete Property on separate sheet
Expected project likelihood (check all that apply):		
<input checked="" type="checkbox"/> Increase Commercial activity	<input type="checkbox"/> Retain employment	<input checked="" type="checkbox"/> Revitalize urban areas
<input checked="" type="checkbox"/> Create employment	<input type="checkbox"/> Prevent a loss of employment	<input type="checkbox"/> Increase number of residents in the community in which the facility is situated
Indicate the number of jobs to be retained or created as a result of rehabilitating the facility, including expected construction employment: 90		
Each year, the State Treasurer may approve 25 additional reductions of half the school operating and state education taxes for a period not to exceed six years. Check the following box if you wish to be considered for this exclusion. <input checked="" type="checkbox"/>		

APPLICANT'S CERTIFICATION

The undersigned, authorized officer of the company making this application certifies that, to the best of his/her knowledge, no information contained herein or in the attachments hereto is false in any way and that all of the information is truly descriptive of the property for which this application is being submitted. Further, the undersigned is aware that, if any statement or information provided is untrue, the exemption provided by Public Act 146 of 2000 may be in jeopardy.

The applicant certifies that this application relates to a rehabilitation program that, when completed, constitutes a rehabilitated facility, as defined by Public Act 146 of 2000, as amended, and that the rehabilitation of the facility would not be undertaken without the applicant's receipt of the exemption certificate.

It is further certified that the undersigned is familiar with the provisions of Public Act 146 of 2000, as amended, of the Michigan Compiled Laws; and to the best of his/her knowledge and belief, (s)he has complied or will be able to comply with all of the requirements thereof which are prerequisite to the approval of the application by the local unit of government and the issuance of an Obsolete Property Rehabilitation Exemption Certificate by the State Tax Commission.

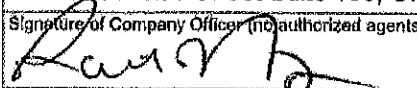
Name of Company Officer (no authorized agents) Robert Furley	Telephone Number (402) 493-2800	Fax Number
Mailing Address 11506 Nicholas Street Suite 100, Omaha NE, 68154		Email Address bfurley@dialrealtycorp.com
Signature of Company Officer (no authorized agents) 		Title Manager

LOCAL GOVERNMENT UNIT CLERK CERTIFICATION

The Clerk must also complete Parts 1, 2 and 4 on Page 2. Part 3 is to be completed by the Assessor.

Signature	Date application received
-----------	---------------------------

FOR STATE TAX COMMISSION USE

Application Number	Date Received	LUCI Code
--------------------	---------------	-----------

LOCAL GOVERNMENT ACTION

This section is to be completed by the clerk of the local governing unit before submitting the application to the State Tax Commission. Include a copy of the resolution which approves the application and Instruction items (a) through (f) on page 1, and a separate statement of obsolescence from the assessor of record with the State Assessor's Board. All sections must be completed in order to process.

PART 1: ACTION TAKEN

Action Date: _____		
<input type="checkbox"/> Exemption Approved for _____ Years, ending December 30, _____ (not to exceed 12 years)		
<input type="checkbox"/> Denied		
Date District Established	LUCI Code	School Code

PART 2: RESOLUTIONS (the following statements must be included in resolutions approving)

<p>A statement that the local unit is a Qualified Local Governmental Unit.</p> <p>A statement that the Obsolete Property Rehabilitation District was legally established including the date established and the date of hearing as provided by section 3 of Public Act 146 of 2000.</p> <p>A statement indicating whether the taxable value of the property proposed to be exempt plus the aggregate taxable value of property already exempt under Public Act 146 of 2000 and under Public Act 198 of 1974 (IFT's) exceeds 5% of the total taxable value of the unit.</p> <p>A statement of the factors, criteria and objectives, if any, necessary for extending the exemption, when the certificate is for less than 12 years.</p> <p>A statement that a public hearing was held on the application as provided by section 4(2) of Public Act 146 of 2000 including the date of the hearing.</p> <p>A statement that the applicant is not delinquent in any taxes related to the facility.</p> <p>If it exceeds 5% (see above), a statement that exceeding 5% will not have the effect of substantially impeding the operation of the Qualified Local Governmental Unit or of impairing the financial soundness of an affected taxing unit.</p> <p>A statement that all of the items described under "Instructions" (a) through (f) of the Application for Obsolete Property Rehabilitation Exemption Certificate have been provided to the Qualified Local Governmental Unit by the applicant.</p>	<p>A statement that the application is for obsolete property as defined in section 2(h) of Public Act 146 of 2000.</p> <p>A statement that the commencement of the rehabilitation of the facility did not occur before the establishment of the Obsolete Property Rehabilitation District.</p> <p>A statement that the application relates to a rehabilitation program that when completed constitutes a rehabilitated facility within the meaning of Public Act 146 of 2000 and that is situated within an Obsolete Property Rehabilitation District established in a Qualified Local Governmental Unit eligible under Public Act 146 of 2000 to establish such a district.</p> <p>A statement that completion of the rehabilitated facility is calculated to, and will at the time of issuance of the certificate, have the reasonable likelihood to, increase commercial activity, create employment, retain employment, prevent a loss of employment, revitalize urban areas, or increase the number of residents in the community in which the facility is situated. The statement should indicate which of these the rehabilitation is likely to result in.</p> <p>A statement that the rehabilitation includes improvements aggregating 10% or more of the true cash value of the property at commencement of the rehabilitation as provided by section 2(l) of Public Act 146 of 2000.</p> <p>A statement of the period of time authorized by the Qualified Local Governmental Unit for completion of the rehabilitation.</p>
--	---

PART 3: ASSESSOR RECOMMENDATIONS

Provide the Taxable Value and State Equalized Value of the Obsolete Property, as provided in Public Act 146 of 2000, as amended, for the tax year immediately preceding the effective date of the certificate (December 31st of the year approved by the STC).

	Taxable Value	State Equalized Value (SEV)
Building(s)		
Name of Governmental Unit	Date of Action on application	Date of Statement of Obsolescence

PART 4: CLERK CERTIFICATION

The undersigned clerk certifies that, to the best of his/her knowledge, no information contained herein or in the attachments hereto is false in any way. Further, the undersigned is aware that if any information provided is untrue, the exemption provided by Public Act 146 of 2000 may be in jeopardy.

Name of Clerk	Clerk Signature	Date	
Clerk's Mailing Address	City	State	ZIP Code
	Telephone Number	Fax Number	Email Address

Mail completed application and attachments to: Michigan Department of Treasury
 State Tax Commission
 P.O. Box 30471
 Lansing, Michigan 48909-7971

If you have any questions, call (517) 373-2408.

For guaranteed receipt by the State Tax Commission, It is recommended that applications and attachments are sent by certified mail.

EQUALIZATION DEPARTMENT

COUNTY OF DELTA

310 LUDINGTON STREET
ESCANABA, MICHIGAN 49829

JULI KOLBE, MMAO, DIRECTOR
LEE ANNE STRAND, MCAO
EQUALIZATION OFFICE MANAGER

TELEPHONE (906) 789-5109
FAX (906) 789-5188
Office Hours 8 a.m. to 4 p.m.

October 10, 2016

Statement of Obsolescence for 301 N Lincoln Road, Escanaba Michigan owned by DIAL Escanaba Mall LP.

The building that is the subject of this request is an enclosed Commercial Shopping Center that was built in 1970 and consists of 240,428 square feet. The mall consists of an anchor store of JC Penney with 29 retail spaces and a food court. The food court currently has room for 3 food counters. On the day of inspection all 3 were vacant.

Retail spaces are leased and lease holders are responsible for leasehold improvements. The mall is currently approximately 1/3 vacant.

The original roof is a steel deck with a rubber membrane is at the end of its physical life as there is evidence of this throughout the mall with rusted skylights and water damaged drywall.

The plumbing is inadequate and does not meet ADA requirements. There are 4 public restrooms, each one includes 3 stalls each and 2 sinks. HVAC is original to the building and is over 40 years old and is inadequate. The electrical fixtures are outdated and need to be upgrade for energy efficiency.

The interior of the building currently has a poor layout. The public walkways of the mall are carpeted. The carpet has truly outlived its physical life.

The parking lot is in poor condition and the signage for the shopping center is almost absent.

Obsolescence is apparent in the lack of modern and efficient electrical, plumbing and mechanical systems. In the opinion of this Equalization Director, this property suffers in excess of 50% of physical and functional obsolescence.

JuliAnne L. Kolbe, MMAO
Delta County Equalization Director
310 Ludington St
Escanaba, MI 49829

Escanaba

NOTICE OF PUBLIC HEARING

IN ACCORDANCE WITH ACT 146 OF 2000 THE CITY OF ESCANABA HEREBY NOTIFIES YOU THAT THE CITY COUNCIL WILL HOLD A PUBLIC HEARING AT 7:00 P.M. ON THURSDAY, NOVEMBER 1, 2018 IN THE COUNCIL CHAMBERS OF CITY HALL, 410 LUDINGTON STREET, TO CONSIDER APPROVAL OF OBSOLETE PROPERTY REHABILITATION EXEMPTION APPLICATION FOR DISTRICT NO. 25 - 301 NORTH LINCOLN ROAD.

DISTRICT 25 - 301 North Lincoln Road
Obsolete Property Rehabilitation District Number 25

SEC 25 T39N R23W (13.16 AC)

PRT OF BLKS 7, 8 & 9 OF THE CITY CENTER ADDITION NO. 3 & PRT OF SE 1/4 OF NE 1/4 SEC 25 FRM THE E 1/4 COR OF SEC 25 TH N0D39'E 211.81 FT TH N89D14'40"W 50 FT TO INT OF N R/W LN OF 1ST AVE NO. & W R/W LN STATE HWY M35 TH N89D58'W 100 FT TO POB TH N89D58'W 550.48 FT TH NORTH 361 FT TH N89D58'W 229.8 FT TH N0D05'39"E 366.06 FT TH N84D50'E 893.52 FT TO W R/W STATE HWY M35 TH S0D39'W 160.83 FT TH S84D50'W 150.73 FT TH S0D39'W 42.30 FT TH S89D21'E 150 FT TH S0D39'W 450 FT TH N89D58'W 100 FT TH S0D39'W 100 FT TO POB (Includes Parcel Numbers - 051-120-2825-278-001, 051-120-2825-278-004, 051-120-2825-278-005 and 051-120-2825-278-006)

ALL PERSONS INTERESTED WILL BE GIVEN AN OPPORTUNITY TO BE HEARD.

TAMMY A. WEISSERT, CMC
INTERIM CITY CLERK
www.escanaba.org

**RESOLUTION TO APPROVE AN APPLICATION FOR
OBSOLETE PROPERTY REHABILITATION EXEMPTION FOR
DP MANAGEMENT, LLC NO. 25**

- Whereas,** Pursuant to P.A. 146 of 2000, the City of Escanaba is a Qualified Local Governmental Unit eligible to establish one or more Obsolete Property Rehabilitation Districts; and
- Whereas,** The City of Escanaba Legally established Obsolete Properties Rehabilitation District No. 25 on July 21, 2016, pursuant to a public hearing held on that date; and
- Whereas,** The taxable value of this exemption plus the aggregate taxable value of property already exempt under PA 146 of 2000 and under PA 198 of 1974 does not exceed 5% of the total taxable value of the City of Escanaba; and
- Whereas,** The applicant is not delinquent in any taxes related to the facility; and
- Whereas,** The applicant has provided all required items to the City of Escanaba; and
- Whereas,** The application is for obsolete property as defined in Sec. 2(h) of Public Act 146 of 2000; and
- Whereas,** Rehabilitation of this facility as covered by this exemption had not begun prior to July 21, 2016, the date the district was established; and
- Whereas,** The application relates to a rehabilitation program that, when completed, constitutes a rehabilitated facility within the meaning of PA 146 of 2000, situated within an Obsolete Property Rehabilitation District; and
- Whereas,** Completion of the rehabilitated facility is calculated to, and will, at the time of issuance of the certificate, have the reasonable likelihood to increase commercial activity, to create employment, to retain employment, and to revitalize an urban area; and
- Whereas,** The rehabilitation includes improvements aggregating 10% or more of the true cash value of the property at commencement of the rehabilitation as provided by Sec. 2(l) of PA 146 of 2000; and
- Whereas,** The application was approved at a public hearing on July 6, 2017, provided by Sec. 4(2) of PA 146 of 2000, allowing a period of thirty-seven (37) months for completion of the rehabilitation;

Mission Statement:



Enhancing the enjoyment and livability of our community by providing quality municipal services to our citizens.
The City of Escanaba is an equal opportunity employer and provider.

Now, Therefore, Be It Resolved by the City Council of the City of Escanaba that DP MANAGEMENT, LLC 301 North Lincoln Road

Be and is hereby granted an Obsolete Property Rehabilitation Exemption for the real property located in Obsolete Property Rehabilitation District No. 25 at 301 North Lincoln Road, described as • SEC 25 T39N R23W [13.16 AC]

PRT OF BLKS 7, 8 & 9 OF THE CITY CENTER ADDITION NO. 3 & PRT OF SE1/4 OF NE1/4 SEC 25 FRM THE E1/4 COR OF SEC 25 TH N0D39'E 211.81 FT TH N89D14'40"W 50 FT TO INT OF N R/W LN OF 1ST AVE NO & W R/W LN STATE HWY M35 TH N89D58'W 100 FT TO POB TH N89D58'W 550.48 FT TH NORTH 361 FT TH N89D58'W 229.8 FT TH N0D05'39"E 366.06 FT TH N84D50'E 893.52 FT TO W R/W STATE HWY M35 TH S0D39'W 160.83 FT TH S84D50'W 150.73 FT TH S0D39'W 82.39 FT TH S89D21'E 150 FT TH S0D39'W 450 FT TH N89D58'W 100 FT TH S0D39'W 100 FT TO POB. (Includes Parcel Numbers – 051-120-2825-278-001, 051-120-2825-278-004, 051-120-2825-278-005 and 051-120-2825-278-006).

For a period of twelve years beginning December 31, 2018, and ending December 31, 2030.

Upon a call of the roll, the vote was as follows:

Ayes:

Nays:

RESOLUTION DECLARED ADOPTED

STATE OF MICHIGAN)

ss

COUNTY OF DELTA)

I the undersigned, being duly qualified and acting City Clerk of the City of Escanaba, do hereby certify that the foregoing constitutes a true and complete copy of a resolution adopted by the Escanaba City Council of the City of Escanaba, County of Delta, Michigan, at a regular City Council Meeting held on Thursday, November 1, 2018, and that said meeting was conducted and public notice was given pursuant to and in full compliance with the Open Meetings Act, Act 267, Public Acts of Michigan, and that the minutes of said meeting were kept and will be or have been made available as required by said Act.

Tammy A. Weissert, CMC
Interim City Clerk

P.H. - #3

CC. 11/1/18

MEMORANDUM

Date: October 15, 2018
To: Patrick Jordan, City Manager
From: Bob Valentine, City Treasurer
Subject: November 1, 2018 Council Agenda Item

I have requested that a public hearing be held at the November 1st council meeting for the purpose of obtaining public comment on a proposed \$100,000 MEDC/CDBG loan to Northern Machining & Repair, Inc. The loan is being processed and underwritten by Northern Initiatives, using the City's CDBG funds which were previously transferred to them. MEDC has retained oversight of the CDBG loan program, and they require that a public hearing be held before they will authorize the loan.

Attached is a draft resolution in a format required by MEDC. Also attached is a copy of the public notice, using a template from MEDC, which originally ran in the Daily Press on October 8, 2018, with a second run date TBD.

Let me know if you require any further documentation. Thanks.

RESOLUTION

APPLICATION FOR FUNDING THROUGH THE CITY OF ESCANABA

**STATE OF MICHIGAN COMMUNITY DEVELOPMENT BLOCK GRANT (CDBG) REVOLVING LOAN FUND
(RLF) PROGRAM FOR NORTHERN MACHINING & REPAIR, INC.**

WHEREAS, Northern Machining & Repair, Inc. has made application through Northern Initiatives, Inc. for the City of Escanaba CDBG Revolving Loan Funds in the amount of \$100,000 to aid with equipment purchases within the City of Escanaba, and

WHEREAS, the project location meets zoning requirement is consistent with the City of Escanaba's Comprehensive Plan, the project will employ at least 51% low to moderate income persons, and

WHEREAS, The City of Escanaba participates in the Regional RLF Model, has executed a Subrecipient Agreement with Northern Initiatives and has designated The City Treasurer and the Escanaba Economic Development Corporation Chair as its representatives on its Regional Funs Approval Committee, and

WHEREAS, the Regional Fund Approval Committee has reviewed and approved said application submitted by Northern Machining & Repair, Inc. on 9/6/2018 and

WHEREAS, no project costs (CDBG and non-CDBG) will be incurred prior to the formal loan award, completion of the environmental review procedures and formal, written authorization to incur costs has been provided by your CDBG Project Manager, and

WHEREAS, The City of Escanaba has advertised in the Daily Press newspaper and has held a public informational hearing in regard to the CDBG Revolving Loan Fund application on November 1, 2018.

THEREFORE BE IT FURTHER RESOLVED that The City of Escanaba acknowledges that it has held a public informational meeting on November 1, 2018 in regard to the CDBG Revolving Loan Fund Application by Northern Machining & Repair, Inc. in the amount of \$100,000 for equipment for its business within the City of Escanaba, that the project will employ at least 51% low to moderate income persons and the project meets zoning requirements and is consistent with the City of Escanaba's Comprehensive Plan and authorizes the Mayor Marc Tall to sign the part 2 Application and all attachments.

Ayes:

Nays:

RESOLUTION DECLARED ADOPTED.

Mission Statement:



Enhancing the enjoyment and livability of our community by providing quality municipal services to our citizens.
The City of Escanaba is an equal opportunity employer and provider.

**NOTICE OF PUBLIC HEARING FOR MICHIGAN
COMMUNITY DEVELOPMENT BLOCK GRANT (CDBG)
REVOLVING LOAN FUND (ELF) FUNDING FOR
NORTHERN MACHINE & REPAIR**

City of Escanaba will conduct a public hearing on November 1, 2018 at 7:00 pm in the Council Chambers, at the City of Escanaba's City Hall, 410 Ludington Street, Escanaba, Michigan for the purpose of affording citizens an opportunity to examine and submit comments on the proposed application for a loan through the CDBG 1 Revolving Loan Fund (ELF) Program.

City of Escanaba proposes to lend \$100,000.00 of CDBG/RLF program funds to Northern Machining & Repair, Inc. to assist with its equipment needs. This will result in the hiring of (5) new employees, 51% of whom have been previously classified as low to moderate income persons. No individuals will be displaced as a result of the proposed activities.

Further information, CDBG/RLF application is available for review. To inspect the documents, please contact City Manager, Patrick Jordan, to review at City Hall. Comments may be submitted in writing through November 1, 2018, by 4:00pm, or made in person at the public hearing.

Citizen views and comments on the proposed application are welcome.

**City of Escanaba Patrick Jordan,
Manager 410 Ludington Street Escanaba, MI 49829**



September 25, 2018

Shawne Haddad
Michigan Economic Development Corporation
Community Development Block Grant Program
300 North Washington Square
Lansing, Michigan 48913

Re: Exempt Activities Determination
Northern Machining and Repair III

Dear Ms. Haddad

The City of Escanaba is hereby requesting release of funds for the Northern Machining and Repair III CDBG revolving loan fund project. The funding will provide support for operational costs associated with plans to increase employment (3 new hires) and the purchase of equipment (new metal band saw and three welding machines) to allow the firm to meet increased demand for fabrication and service and repairs. This activity (operation costs not associated with construction or expansion of existing operations) is a categorically excluded activity, which is not subject to 24 CFR 58.5. Such activities are exempt from environmental review requirements under 24 CFR 58.34(a).

In addition, the City of Escanaba has reviewed and documented that we are in compliance with the requirement of 24 CFR 58.6 as follows:

1. The project will not involve property acquisition or construction residing in an area identified by the Federal Emergency Management Agency (FEMA) as having special flood hazards.
2. The project will not take place in an area designated as part of the Coastal Barrier Resources System.
3. The project will not involve the sale or acquisition of an existing property in a Runway Clear Zone or Clear Zone, as defined in 24 CFR Part 51.

Please call if you need any additional information.

Sincerely,

Marc D. Tall, Mayor
Certifying Officer

Mission Statement:



Enhancing the enjoyment and livability of our community by providing quality municipal services to our citizens.
The City of Escanaba is an equal opportunity employer and provider.

DETERMINATION OF LEVEL OF ENVIRONMENTAL REVIEW

CERTIFYING OFFICER

Marc D. Tall, Mayor of the City of Escanaba, is designated the environmental certifying officer for the CDBG project described below. I certify that

PROJECT INFORMATION

Grantee (Unit of General Local Government) City of Escanaba

Grantee Address 410 Ludington Street
 Escanaba MI 49829

Grantee Contact Person
Name and Phone Dale J. Cook 715-923-0620

Other Project Contact Person
Name and Phone Robert Valentine 906-789-7305

Grant Number (if assigned)

Project Title Northern Machining Repair III

Project Description

Northern Machining and Repair, Inc. is a local business specializing in heavy industrial maintenance, machining, welding, sales, and fabrication. The company is seeking \$100,000 to be used for the purchase of a new metal band saw and three welding machines. Purchase of the equipment will allow the firm to hire three new employees and continue to meet the increased demand for fabrication and service and repairs.

PROJECT DETERMINATION (completed by the Environmental Review Officer)

All project activities have been reviewed and the project meets the following environmental determination:

- Exempt
- Categorically Excluded Not Subject To §58.5
- Categorically Excluded Subject To §58.5
- Environmental Assessment
- Environmental Impact Statement

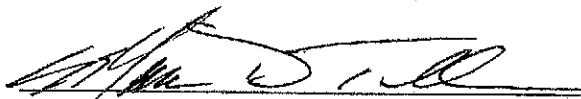

Certifying Officer Signature
Marc D. Tall, Mayor-City of Escanaba

September 25, 2018
Date

**FINDING OF CATEGORICAL EXCLUSION
(not subject to 58.5)
24 CFR 58.35(b)**

Grantee City of Escanaba
Grant No. Northern Machining & Repair III

I hereby certify that the following activities comprising the Northern Machining and Repair III Project have been reviewed and determined to be Categorically Excluded per 24 CFR 58.35(b) as follows:

- (1) Tenant-based rental assistance;
- (2) Supportive services including, but not limited to, health care, housing services, permanent housing placement, day care, nutritional services, short-term payments for rent/mortgage/utility costs, and assistance in gaining access to local, State, Federal government benefits and services;
- (3) Operation costs, including but not limited to, equipment purchases, inventory financing, interest subsidy, operation expenses, and similar costs not associated with construction or expansion of existing operations;
- (4) Economic development activities, including but not limited to, equipment purchases, inventory financing, interest subsidy, operating expenses and similar costs not associated with construction or expansion of existing operations;
- (5) Activities to assist home ownership of existing dwelling units including closing costs and down payment assistance to home buyers, and similar activities that result in the transfer of title to a property;
- (6) Affordable housing pre-development costs including legal, consulting, developer and other costs related to obtaining site options, project financing, administrative costs and fees for loan commitments, zoning approvals, and other related activities which do not have a physical impact.

Flood Insurance/Flood Disaster Protection Act

1. Does the project involve the acquisition, construction, or rehabilitation of structures, buildings, or mobile homes?

- No. Flood insurance is not required. The review of this factor is completed.
- Yes. Continue Review.

2. Is the structure or part of the structure located in a Federal Emergency Management Agency (FEMA) designated Special Flood Hazard Area?

- No. Cite Source Documentation:
Proceed with project.
- Yes. Cite Source Documentation:
Continue Review.

3. Is the community participating in the National Flood Insurance Program (or has less than one year passed since FEMA notification of Special Flood Hazards)?

- Yes. Flood insurance under the National Flood Insurance Program must be obtained and maintained for the economic life of the project, in the amount of the total project cost. A copy of the flood insurance policy declaration must be maintained in this Environmental Review Record.
- No. **Federal assistance may not be used in the Special Flood Hazard Area.**

Coastal Barriers Resources Act

1. Is the project located in a coastal barrier resource area?

No. Cite Source Documentation: CBRA map attached

Yes. Federal assistance may not be used in such an area.

Airport Runway Clear Zones and Clear Zones Disclosures

1. Does the project involve the sale or acquisition of existing property within a Civil Airport's Runway Clear Zone, Approach Protection Zone or a Military Installation's Clear Zone?

No. Cite Source Documentation: Delta County airport map attached

Yes. Disclosure statement must be provided and a copy of the signed disclosure statement must be maintained in this Environmental Review Record.

In accordance with 24 CFR 58.35(b), no further environmental approval form from HUD or the State is necessary for the drawdown of funds to implement this program.

Marc D. Tall, Mayor

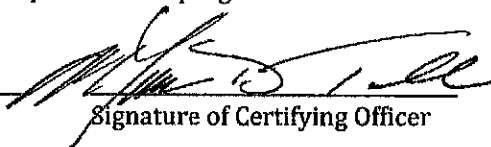

Sept. 25, 2018

Name and Title of Certifying Officer

Signature of Certifying Officer

Date

Peter Van Steen

906.786.9234

Name of person preparing this form

Phone #

For State Use Only	Reviewed	Date
Compliance Specialist		

JOHN H. CHAFEE COASTAL BARRIER RESOURCES SYSTEM

MICHIGAN

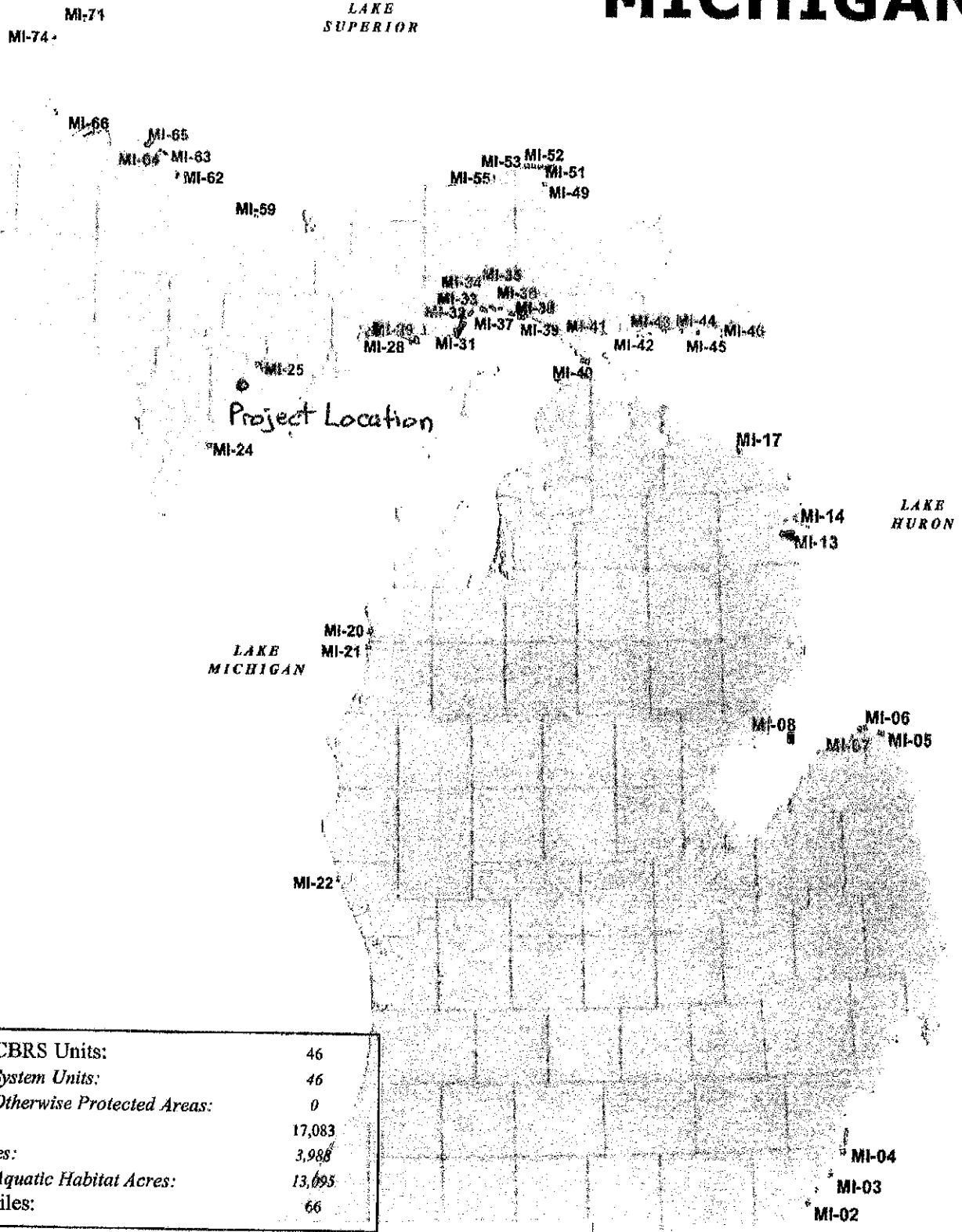

Number of CBRS Units:	46
Number of System Units:	46
Number of Otherwise Protected Areas:	0
Total Acres:	17,083
Upland Acres:	3,988
Associated Aquatic Habitat Acres:	13,095
Shoreline Miles:	66

Boundaries of the John H. Chafee Coastal Barrier Resources System (CBRS) shown on this map were transferred from the official CBRS maps for this area and are depicted on this map (in red) for informational purposes only. The official CBRS maps are enacted by Congress via the Coastal Barrier Resources Act, as amended, and are maintained by the U.S. Fish and Wildlife Service. The official CBRS maps are available for download at <http://www.fws.gov/CBRA>.

Map Date: March 14, 2016



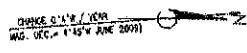
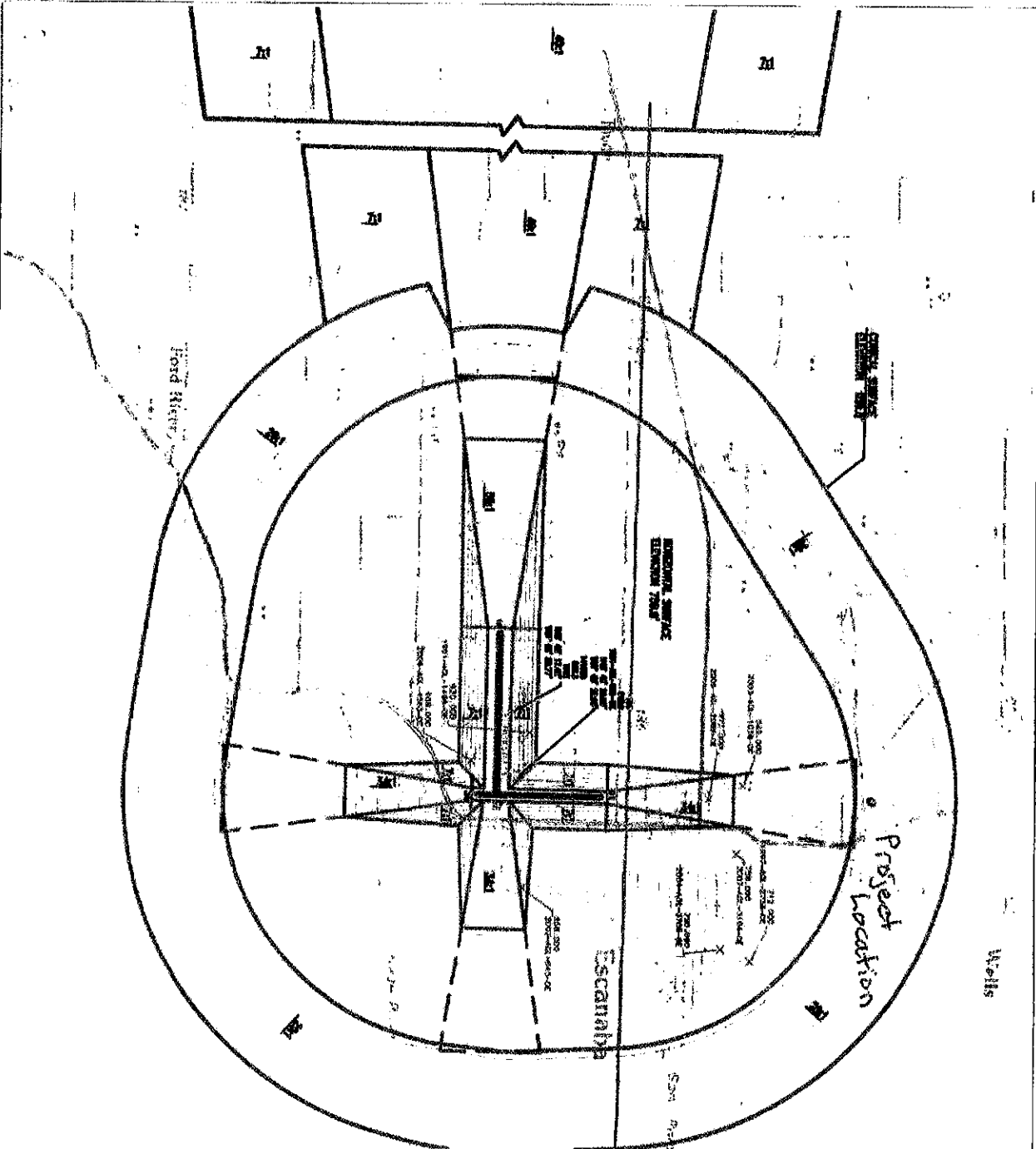

Code Number	Elevation	Notes
2007-02-310A-02	799'	Water Tank
2009-02-2002-02	672'	Bill Bldg
1981-02-1488-02	630'	Other w/o AAI
1987-02-2738-02	712'	Other w/o AAI
2002-02-644-02	688'	Other w/o AAI
2002-02-1034-02	742'	AREAS
2007-02-2728-02	720'	AREAS
2009-02-053-02	609'	50' x 100'

ESTABLISHED AIRPORT EL. = 609.0'
 AIRPORT REFERENCE POINT
 EXISTING
 LAT. 45°43'21.62"N,
 LONG. 87°05'36.69"W

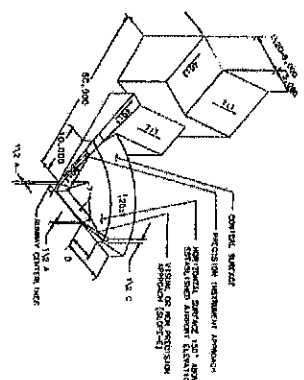

Code	Dimensions	Structure Name	Notes
1	200' x 100'	Medical Service Elevation Tower	Existing
2	200' x 100'	Control Tower	Existing
3	200' x 100'	Other Building	Existing
4	200' x 100'	Other Building	Existing
5	200' x 100'	Other Building	Existing
6	200' x 100'	Other Building	Existing
7	200' x 100'	Other Building	Existing
8	200' x 100'	Other Building	Existing
9	200' x 100'	Other Building	Existing
10	200' x 100'	Other Building	Existing

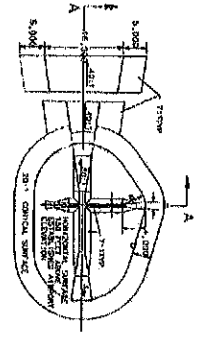

12 OF 12
 DRAWING
 12395541

21-1
 LOC B
 ESC

Delta County Airport
 FLY FROM NEARBY
 FAR PART 77 APPROACH SURFACES DRAWING

ALP UPDATE
 ESCANABA, MICHIGAN

URS
 CONSULTING ENGINEERS

DATE	ISSUED FOR

CDBG LOAN PROGRAM (CLP) APPLICATION

Use tab key to advance through document. Complete CLP Application in entirety and submit via email to Specialist.

UNIT OF GENERAL LOCAL GOVERNMENT (UGLG) IDENTIFICATION SUMMARY

IDENTIFICATION OF UGLG		FUNDING SOURCES <i>(if multiple properties, include all)</i>	
Unit of General Local Government (UGLG)	City of Escanaba	CDBG/ CDBG RLF	100,000
Street/PO Box	410 Ludington Street.	UGLG	\$
City	Escanaba	Private	\$
County	Delta	Other	\$
State/Zip	MI. 49829	Other	\$
Fiscal Year	6/30/2018	Other	\$
Chief Elected Official Name	Marc Tall	Other	\$
Chief Elected Official Title	Mayor	TOTAL	100,000
Chief Elected Official Email	mtall@escanaba.org	# of FTEs 3.0 Must not exceed \$35,000 per FTE	
UGLG Project Contact (PC) Name	Robert Valentine	UGLG SAM # 46XZB www.sam.gov	
UGLG PC Title	City Treasurer	UGLG DUNS # 86-183043 http://www.dnb.com/duns-number.html	
UGLG PC Address	410 Ludington St., Escanaba, MI. 49829	UGLG Federal ID # 38-600479	
UGLG PC Telephone Number	906 786-0522	UGLG Fiscal Year 7/1/2018 to 6/30/2019	
UGLG PC Fax Number		Census Tract # for Project 260419708.00	
UGLG PC E-Mail Address	bvalentine@escanaba.org		
STATE GOVERNMENT REPRESENTATION			
Senator Name	Tom Casperson	Senate District	38
Representative Name	Beau LaFave	House District	110
FEDERAL GOVERNMENT REPRESENTATION			
Representative Name	Jack Bergman	Congressional District	1

CLP FUND	Available Balance	\$ 605,922.00
	Less This Loan	\$ 100,000.00
	New Balance	\$ 505,922.00

Northern Machining & Repair III

UGLG CAPACITY AND CONFLICT OF INTEREST									
1	<p>Identify consultants who will be responsible for administering the proposed:</p> <p><input type="checkbox"/> NA, consultant not yet known <input checked="" type="checkbox"/> NA, consultant not anticipated <input type="checkbox"/> Consultant has been identified and contact information provided below:</p> <table border="1"> <tr> <td>Name</td> <td></td> </tr> <tr> <td>Address</td> <td></td> </tr> <tr> <td>Phone</td> <td></td> </tr> <tr> <td>Email</td> <td></td> </tr> </table>	Name		Address		Phone		Email	
Name									
Address									
Phone									
Email									
2	<p><input checked="" type="checkbox"/> Yes <input type="checkbox"/> No <input type="checkbox"/> NA</p> <p>Has the UGLG received CDBG grants or loans in the past five years and/or have any open CDBG grants or loans? This includes CDBG grants or loans provided by the MSF/MEDC and all MSHDA CDBG programs. If yes, identify the projects and identify/describe all findings regarding those projects: Northern Initiatives Manages County Revolving Loan Fund using CDBG funds. ***See attached list provided by City of Escanaba***</p>								
3	<p><input checked="" type="checkbox"/> Yes <input type="checkbox"/> No <input type="checkbox"/> NA</p> <p>Does the applicant have any outstanding CDBG grants or loans that have not been drawn down? If yes, describe: Northern Machining & Repair has two active loans with the program totaling and outstanding balance of \$207,749. The first loan originally approved for \$100 has met the job creation goals and was succeeded by the MEDC. The second is close to meeting the hiring objectives.</p>								
4	<p><input type="checkbox"/> Yes <input checked="" type="checkbox"/> No <input type="checkbox"/> NA</p> <p>Will local officials and staff be a party to any contract involving the procurement of goods and services assisted with CDBG funds? If yes, describe:</p>								
5	<p><input type="checkbox"/> Yes <input checked="" type="checkbox"/> No <input type="checkbox"/> NA</p> <p>Will any person who is an employee, agent, consultant, officer, elected or appointed official of the UGLG obtain a financial interest or benefit from a CDBG assisted activity or have an interest in any contract, subcontract or agreement with respect thereto, or in the proceeds hereunder, either for themselves or for those with whom they have family or business ties, during their tenure or for one year thereafter? If yes, describe:</p>								
6	<p>Indicate whether or not the UGLG has a contractual relationship with any of the following entities:</p> <p><input type="checkbox"/> Yes <input checked="" type="checkbox"/> No Boge, Wybenga & Bradley, PC <input type="checkbox"/> Yes <input checked="" type="checkbox"/> No Farm Bureau <input type="checkbox"/> Yes <input checked="" type="checkbox"/> No Fifth Third Bank <input type="checkbox"/> Yes <input checked="" type="checkbox"/> No Grand Angels <input type="checkbox"/> Yes <input checked="" type="checkbox"/> No Greenstone Farm Credit Services <input type="checkbox"/> Yes <input checked="" type="checkbox"/> No Michigan Department of Licensing & Regulatory Affairs <input type="checkbox"/> Yes <input checked="" type="checkbox"/> No Michigan Department of Treasury <input checked="" type="checkbox"/> Yes <input type="checkbox"/> No Michigan Economic Development Corporation <input type="checkbox"/> Yes <input checked="" type="checkbox"/> No Springfield Smartroof <input type="checkbox"/> Yes <input checked="" type="checkbox"/> No Trustcott Rossman</p> <p>If yes to any of the above, describe the nature of relationship: CDBG Fund with Northern Initiatives.</p>								
7	<p><input checked="" type="checkbox"/> Yes <input type="checkbox"/> No <input type="checkbox"/> NA</p> <p>UGLG will adhere to HUD, CDBG and MEDC rules, regulations and Grant Administration Manual requirements, policies, procedures and reporting requirements.</p>								
8	<p><input type="checkbox"/> Yes <input type="checkbox"/> No <input checked="" type="checkbox"/> NA</p> <p>Consultant will adhere to HUD, CDBG and MEDC rules, regulations and Grant Administration Manual requirements, policies, procedures and reporting requirements.</p>								

Northern Machining & Repair III

9	<input checked="" type="checkbox"/> Yes <input type="checkbox"/> No <input type="checkbox"/> NA	UGLG and Consultant have read the Definitions and Instructions to Attachment D, Estimated Employment Creation and/or Retention Form , and understand how to calculate and report Full-Time Job (FT) and Full-Time Equivalent Job (FTE) jobs for the base number of Existing Jobs <u>and</u> the number of Jobs to be Created. (An updated Attachment D is required to be submitted with the Request to Close memo).		
PROJECT DESCRIPTION				
9	Provide a clear and concise description of the overall proposed project including all work activities, number of businesses/properties involved, the type of assistance needed and why: The loan request will be used for the purchase of a new metal band saw and 3 welding machines. \$100,000.00 of RLF funding will support this equipment and will assist with the hiring of 3 new employees. Additional labor and equipment resources are required to keep up with fabrication service and repair demand.			
10	Provide the history of the problems associated with this project and explain how this project will help alleviate those problems. None at this time.			
11	Check all that apply and/or will occur for this project: Comments: <table style="width: 100%; border: none;"> <tr> <td style="width: 50%; vertical-align: top; padding: 5px;"> National Objective <input type="checkbox"/> Elimination/Prevention of Slum/Blight <input type="checkbox"/> Immediate threat / urgent need <input checked="" type="checkbox"/> Benefit persons of low/mod income <input checked="" type="checkbox"/> Job Creation <input type="checkbox"/> Housing Projects <input type="checkbox"/> Infrastructure Projects Procurement <input type="checkbox"/> Procurement of contractors <input type="checkbox"/> Work to be done by owner <input type="checkbox"/> Work to be done by sole proprietor contractor Section 3 <input type="checkbox"/> Section 3 required - CDBG over \$200k + construction activities Anticipated Environmental Review <input type="checkbox"/> Exempt <input checked="" type="checkbox"/> Categorical Exclusion Not Subject To (CENST) <input type="checkbox"/> Categorical Exclusion Subject To (CEST) <input type="checkbox"/> Environmental Assessment Property Disposition <input type="checkbox"/> Acquisition of building <input type="checkbox"/> Acquisition of property <input type="checkbox"/> Currently has land contract <input type="checkbox"/> Currently has lease <input type="checkbox"/> Purchase Agreement required <input type="checkbox"/> Relocation required </td> <td style="width: 50%; vertical-align: top; padding: 5px;"> Job Activities <input type="checkbox"/> Construction activities (ex: use of hammer and shovels, equipment installation, any digging, etc.) <input type="checkbox"/> Electrical <input type="checkbox"/> Plumbing <input type="checkbox"/> Change in building footprint <input type="checkbox"/> Equipment installation will require major construction <input type="checkbox"/> Equipment installation will require minor construction <input checked="" type="checkbox"/> Equipment is plug and play only <input type="checkbox"/> Davis Bacon required – construction contract over \$2,000 Business <input type="checkbox"/> Seasonal Employer <input checked="" type="checkbox"/> Open year round <input type="checkbox"/> Open year round but ramps staff in spring/summer/fall <input type="checkbox"/> Startup business </td> </tr> </table>		National Objective <input type="checkbox"/> Elimination/Prevention of Slum/Blight <input type="checkbox"/> Immediate threat / urgent need <input checked="" type="checkbox"/> Benefit persons of low/mod income <input checked="" type="checkbox"/> Job Creation <input type="checkbox"/> Housing Projects <input type="checkbox"/> Infrastructure Projects Procurement <input type="checkbox"/> Procurement of contractors <input type="checkbox"/> Work to be done by owner <input type="checkbox"/> Work to be done by sole proprietor contractor Section 3 <input type="checkbox"/> Section 3 required - CDBG over \$200k + construction activities Anticipated Environmental Review <input type="checkbox"/> Exempt <input checked="" type="checkbox"/> Categorical Exclusion Not Subject To (CENST) <input type="checkbox"/> Categorical Exclusion Subject To (CEST) <input type="checkbox"/> Environmental Assessment Property Disposition <input type="checkbox"/> Acquisition of building <input type="checkbox"/> Acquisition of property <input type="checkbox"/> Currently has land contract <input type="checkbox"/> Currently has lease <input type="checkbox"/> Purchase Agreement required <input type="checkbox"/> Relocation required	Job Activities <input type="checkbox"/> Construction activities (ex: use of hammer and shovels, equipment installation, any digging, etc.) <input type="checkbox"/> Electrical <input type="checkbox"/> Plumbing <input type="checkbox"/> Change in building footprint <input type="checkbox"/> Equipment installation will require major construction <input type="checkbox"/> Equipment installation will require minor construction <input checked="" type="checkbox"/> Equipment is plug and play only <input type="checkbox"/> Davis Bacon required – construction contract over \$2,000 Business <input type="checkbox"/> Seasonal Employer <input checked="" type="checkbox"/> Open year round <input type="checkbox"/> Open year round but ramps staff in spring/summer/fall <input type="checkbox"/> Startup business
National Objective <input type="checkbox"/> Elimination/Prevention of Slum/Blight <input type="checkbox"/> Immediate threat / urgent need <input checked="" type="checkbox"/> Benefit persons of low/mod income <input checked="" type="checkbox"/> Job Creation <input type="checkbox"/> Housing Projects <input type="checkbox"/> Infrastructure Projects Procurement <input type="checkbox"/> Procurement of contractors <input type="checkbox"/> Work to be done by owner <input type="checkbox"/> Work to be done by sole proprietor contractor Section 3 <input type="checkbox"/> Section 3 required - CDBG over \$200k + construction activities Anticipated Environmental Review <input type="checkbox"/> Exempt <input checked="" type="checkbox"/> Categorical Exclusion Not Subject To (CENST) <input type="checkbox"/> Categorical Exclusion Subject To (CEST) <input type="checkbox"/> Environmental Assessment Property Disposition <input type="checkbox"/> Acquisition of building <input type="checkbox"/> Acquisition of property <input type="checkbox"/> Currently has land contract <input type="checkbox"/> Currently has lease <input type="checkbox"/> Purchase Agreement required <input type="checkbox"/> Relocation required	Job Activities <input type="checkbox"/> Construction activities (ex: use of hammer and shovels, equipment installation, any digging, etc.) <input type="checkbox"/> Electrical <input type="checkbox"/> Plumbing <input type="checkbox"/> Change in building footprint <input type="checkbox"/> Equipment installation will require major construction <input type="checkbox"/> Equipment installation will require minor construction <input checked="" type="checkbox"/> Equipment is plug and play only <input type="checkbox"/> Davis Bacon required – construction contract over \$2,000 Business <input type="checkbox"/> Seasonal Employer <input checked="" type="checkbox"/> Open year round <input type="checkbox"/> Open year round but ramps staff in spring/summer/fall <input type="checkbox"/> Startup business			

Northern Machining & Repair III

PROJECT SCHEDULE		
12	Provide an overall project schedule that includes the anticipated start and completion dates.	
NOTE: When completing the schedule, please refer to Application Guide with regard to when project costs can be incurred. This schedule will be incorporated into the Loan Exhibit with the UGLG.		
	ACTIVITIES	START DATE
	Engineering and/or Design	
	Property Acquisition	
	Bidding	
	CDBG-funded Activities	10/15/2018
	UGLG-funded Activities	
	Other-funded Activities	
	Job Creation	10/15/2018
		10/15/2018

AUTHORIZED UGLG OFFICIAL	
Signature	
Name and Title	Robert Valentine / Treasurer
Date	8/16/18

Northern Machining & Repair III

ATTACHMENT A

PROJECT BUDGET

Complete this Project Budget to identify all funding sources and all project activities. List the specific source and dollar amount of any local, state, or other federal funding associated with this project including grants and/or loans. Tax incentives should NOT be included on the project budget.

- For general contractors - Attach 3 cost estimates or an independent third party quote for all CDBG-funded costs.
- For sole proprietor contractors – Attach 1 cost estimate
- For equipment – Attach list of items and cost or a screen print of items to be purchased.
- Attach an appraisal for CDBG-funded acquisitions.

NOTE: Costs for preparing independent cost estimates may be incurred at the UGLG's own risk without written authorization, but may not be included in the project budget as match. Refer to Application Guide for guidance on administrative costs.

Applicant	Northern Machining & Repair
Project Title	Northern Machining & Repair III

ACTIVITIES	CDBG	LOCAL	PRIVATE	OTHER	OTHER	TOTAL
Acquisition						
Administration						
Architecture / Engineering						
Building Improvements						
Demolition						
Infrastructure Improvements						
Machinery / Equipment	100,000					100,000
Planning						
Working Capital						
Inventory						
Marketing						
Payroll						
Research & Development						
Liquor License						
Training / Consulting						
TOTALS	100,000					100,000

Northern Machining & Repair III

ATTACHMENT B

PROJECT DETAILS FOR BUSINESS/PRIVATE PROPERTY PROJECTS

COMPLETE ONE FOR EACH PROPERTY									
1	<p>Business Information:</p> <table border="1" style="width: 100%;"> <tr> <td style="width: 50%;">Business Name</td> <td>Northern Machining & Repair</td> </tr> <tr> <td>Address City State Zip</td> <td>1701 N 26th St. Escanaba, MI. 49829.</td> </tr> <tr> <td>Current Owner(s)</td> <td>Jon Liss</td> </tr> <tr> <td>Future Ownership</td> <td>Same</td> </tr> </table>	Business Name	Northern Machining & Repair	Address City State Zip	1701 N 26 th St. Escanaba, MI. 49829.	Current Owner(s)	Jon Liss	Future Ownership	Same
Business Name	Northern Machining & Repair								
Address City State Zip	1701 N 26 th St. Escanaba, MI. 49829.								
Current Owner(s)	Jon Liss								
Future Ownership	Same								
2	<p>Provide nature of business and background:</p> <p>Fabrication and machine shop.</p>								
3	<p>Describe the specific work activities to be completed with CDBG funds <u>and</u> match funds (use bullets):</p> <p>Working capital supporting :</p> <ul style="list-style-type: none"> • Equipment purchase 								
4	<p>Describe all leases, easements, and property option/purchase agreements needed in order to complete the project activities at this property location. Please identify all parties involved and any estimated costs associated with these activities:</p> <p><i>NOTE: Incurring costs; including CDBG, local, and private costs prior to authorization and/or completion of the environmental review could jeopardize the proposed CDBG funding.</i></p> <p>Property is owned by Jon Liss</p>								
5	<p>Check all statements that apply regarding occupancy:</p> <p><input checked="" type="checkbox"/> The property does not have occupants (tenants, property owners, etc.). Therefore, the Uniform Relocation Assistance and Real Property Acquisition Policies Act of 1970 will not apply.</p> <p><input type="checkbox"/> The property does have occupants (tenants, property owners, etc.) and the occupants will not be permanently displaced. Please provide the following for each occupant:</p> <table border="1" style="width: 100%;"> <tr> <td style="width: 50%;"> <input type="checkbox"/> Property Owner OR <input type="checkbox"/> Tenant <input type="checkbox"/> Residential OR <input type="checkbox"/> Business Name Address Phone Number Email Address </td> <td style="width: 50%;"></td> </tr> <tr> <td> <input type="checkbox"/> Property Owner OR <input type="checkbox"/> Tenant <input type="checkbox"/> Residential OR <input type="checkbox"/> Business Name Address Phone Number Email Address </td> <td></td> </tr> </table> <p><input type="checkbox"/> The property does have occupants (tenants, property owners, etc.) and the occupants will be permanently displaced. Please provide the following for each occupant:</p> <table border="1" style="width: 100%;"> <tr> <td style="width: 50%;"> <input type="checkbox"/> Property Owner OR <input type="checkbox"/> Tenant <input type="checkbox"/> Residential OR <input type="checkbox"/> Business </td> <td style="width: 50%;"></td> </tr> </table>	<input type="checkbox"/> Property Owner OR <input type="checkbox"/> Tenant <input type="checkbox"/> Residential OR <input type="checkbox"/> Business Name Address Phone Number Email Address		<input type="checkbox"/> Property Owner OR <input type="checkbox"/> Tenant <input type="checkbox"/> Residential OR <input type="checkbox"/> Business Name Address Phone Number Email Address		<input type="checkbox"/> Property Owner OR <input type="checkbox"/> Tenant <input type="checkbox"/> Residential OR <input type="checkbox"/> Business			
<input type="checkbox"/> Property Owner OR <input type="checkbox"/> Tenant <input type="checkbox"/> Residential OR <input type="checkbox"/> Business Name Address Phone Number Email Address									
<input type="checkbox"/> Property Owner OR <input type="checkbox"/> Tenant <input type="checkbox"/> Residential OR <input type="checkbox"/> Business Name Address Phone Number Email Address									
<input type="checkbox"/> Property Owner OR <input type="checkbox"/> Tenant <input type="checkbox"/> Residential OR <input type="checkbox"/> Business									

Northern Machining & Repair III

	Name Address Phone Number Email Address <input type="checkbox"/> Property Owner OR <input type="checkbox"/> Tenant <input type="checkbox"/> Residential OR <input type="checkbox"/> Business Name Address Phone Number Email Address	
6	What is the square footage of private space being improved? The company is comprised of several buildings totaling 80,000 sf. However this space it not being improved nor reactivated.	
7	<input checked="" type="checkbox"/> Yes <input type="checkbox"/> No <input type="checkbox"/> NA	Have CDBG funds been used at this property and/or business address in the past? If yes, describe: Company borrowed funds in November of 2016 and August of 2017 to assist with equipment purchases.
8	Describe the source of the private funding and the status of any necessary approvals for financing: N/A	
9	<input type="checkbox"/> Yes <input checked="" type="checkbox"/> No	Will the project relocate jobs from one labor market area to another? If yes, describe:

Northern Machining & Repair III

ATTACHMENT C

PROJECT SCOPE FOR PUBLIC IMPROVEMENTS (ONLY)

Check if Not Applicable

1	Describe the specific work activities to be completed on UGLG- or publicly-owned property with CDBG funds and match funds.
2	Describe the location and boundaries of the project, including the street address and property ownership (i.e. UGLG property, other public property, private property) where all project activities will occur.
3	What is the square footage of public space being improved or reactivated?
4	Attach a detailed map showing all project activities and any district they are located within (i.e. LDFA).
5	<p>Historic Property Screening: Is the property? (check all that apply):</p> <p><input type="checkbox"/> Listed in the National Register of Historic Properties</p> <p><input type="checkbox"/> Potentially eligible to be listed in the National Register of Historic Properties</p> <p><input type="checkbox"/> Listed in a state or local inventory of historic places</p> <p><input type="checkbox"/> Designated as a state or local landmark or historic district</p> <p><input type="checkbox"/> None of the above</p> <p>Comments:</p>
6	<input type="checkbox"/> Yes <input type="checkbox"/> No Will the project result in the demolition or conversion of residential dwelling units, both occupied and vacant?
7	<input type="checkbox"/> Yes <input type="checkbox"/> No Will the project result in special fees (ie, tap in / hookup fees, special assessments)?
8	<input type="checkbox"/> NA Attach architectural renderings or pictures in color illustrating what the building will look like after project completion.
9	<input type="checkbox"/> NA Other than the preliminary cost estimates, describe the status of any engineering plans or specifications. Attach engineering plans or specifications, if completed. <p><i>NOTE: Costs for engineering and/or architectural plans to be funded with non-CDBG funds may be incurred at the UGLG's own risk with written authorization from the MSF and may be included in the project budget as match.</i></p> <p><i>Costs for engineering and/or architectural plans to be funded with CDBG funds may be incurred with written authorization from the MSF once the Loan Exhibit has been executed and may be included in the project budget. CDBG Procurement requirements apply to all CDBG funded activities. CDBG funds may be jeopardized or withdrawn if written authorization from the MSF has not been provided prior to signing an engineering and/or architectural contract for expenses other than the preliminary costs for completing this Application.</i></p>
10	<input type="checkbox"/> NA Describe all temporary or permanent relocation of businesses, non-profit organizations, homeowners, or tenants needed in order to complete the project. Include the address, names of anticipated displaced parties, type of displacement (residential or business) and whether the parties are owners and/or tenants.

Northern Machining & Repair III

11	<input type="checkbox"/> NA	<p>Describe all leases, easements, and property option/purchase agreements needed in order to complete the project activities at this property location. Include the anticipated seller, buyer, property description/location and cost.</p> <p><i>NOTE: Costs for acquiring real property, to be fully funded with non-CDBG monies, may be included in the project budget as match and may be incurred at the UGLG's own risk once the environmental review and Uniform Act requirements have been completed and written authorization to incur these costs has been provided by the MSF.</i></p> <p><i>Costs for acquiring real property, to be partially or fully funded with CDBG monies, may be included in the project budget and may be incurred with written authorization from the MSF once the environmental review and Uniform Act requirements have been completed and the Loan Exhibit has been executed by all parties.</i></p> <p><i>CDBG funds will be jeopardized or withdrawn if written authorization from the MSF has not been provided prior to signing option/purchase/lease/easement agreements.</i></p>
12	<input type="checkbox"/> NA	<p>List and describe the status of any local, state and federal permits required for implementation of the proposed project.</p>

Northern Machining & Repair III

ATTACHMENT D

ESTIMATED EMPLOYMENT CREATION AND/OR RETENTION FORM

The project is qualified based on the Low and Moderate Income Job Creation National Objective and at least 51% of the beneficiaries must be low and moderate income persons.

UGLG	City of Escanaba	Project Name	Northern Machining & Repair III
Business	Northern Machining & Repair.	Contact Name	Melisa Johnson
Street Address (not POBox)	1701 N 26 th Street	Contact Title	Controller
City State Zip	Escanaba, MI. 49829	Phone #	906 786-0526
DUNS #	128378502	Fax #	906 786-0566
SIC #	TBD	Email Address	mellisa@northernmachining.com
LARA #	800033544	CCR #	

IMPORTANT: Read definitions and instructions on the following page for requirements on how to calculate and report Full-Time Job (FT) and Full-Time Equivalent Job (FTE) jobs. An updated form is required to be submitted with the Request to Close memo.

EMPLOYMENT CATEGORY	EXISTING JOBS		JOBS TO BE CREATED		
	NUMBER OF EXISTING PERMANENT FT AND FTE JOBS	AVERAGE HOURLY WAGE OF EXISTING JOBS	PERMANENT FT AND FTE JOBS TO BE CREATED	NEW HIRES LOWEST STARTING HOURLY WAGE	NEW HIRES AVERAGE STARTING HOURLY WAGE
Managerial	6	36.00			
Professional					
Technical	5	20.00			
Sales					
Clerical	1	13.00			
Craftsmen (skilled)					
Operators (semi-skilled)	34	18.00	3	12.00	15.00
Laborers (unskilled)					
Service Worker					
TOTALS	46	21.75	3		

List Fringe benefits to be provided for created jobs:
Health Insurance

AUTHORIZED COMPANY OFFICIAL

Certification is made that the above data is the most accurate available based on current information and knowledge.

Signature:



Date:

25 Sept 18

Name: Jon Liss

Title: Owner

Northern Machining & Repair III

DEFINITIONS AND INSTRUCTIONS

Full-Time Job (FT) - An employee who has 2,080 hours of paid employment on an annual basis or one that is paid for 35 or more hours per week.

Full-Time Equivalent Job (FTE) – A combination of employees that individually have less than 2080 hours of paid employment on an annual basis or work less than 40 hours per week, and are converted to full-time equivalent (FTE) jobs by dividing the total annual hours worked by 2,080 hours or dividing the total weekly hours worked by 40 hours.

New Job - A new FT or FTE permanent job that did not exist prior to this project and came about as a result of this project. The jobs are intended to be permanent and sustainable. Jobs that exist prior to the start of the project or result independently from the project will not be considered.

Number of Existing Permanent FT and FTE Jobs - Identify the present number of all FT and FTE permanent private sector jobs and the average hourly pay rate of existing jobs.

Permanent FT and FTE Jobs To Be Created - Identify the number of new FT or FTE jobs that did not exist prior to this project and came about as a result of this project. The jobs to be created are intended to be permanent and sustainable. Jobs that exist prior to the start of the project or result independently from the project should not be considered.

Employment Category Definitions:

Managerial	Occupations requiring administrative personnel who set broad policies, exercise overall responsibility for execution of these policies and direct individual departments or special phases of a firm's operations.
Professional	Occupations requiring either college graduation or experience of such kind and amount as to provide a comparative background.
Technical	Occupations requiring a combination of basic scientific knowledge and manual skills which can be obtained through approximately 2 years of post-high school education, such as is offered in many technical institutions and junior colleges, or through equivalent on-the-job training.
Sales	Occupations engaging wholly or primarily in sales.
Clerical	All clerical-type work regardless of level of difficulty, where the activities are primarily non-manual.
Craftsman (skilled)	Manual workers of relatively high skill level having a thorough and comprehensive knowledge of the processes involved in their work; exercise independent judgment and usually require extensive training.
Operators (semi-skilled)	Workers who operate machines or processing equipment or perform other factory-type duties of intermediate skill level which can be mastered in a few weeks and require limited training.
Laborers (unskilled)	Workers in manual occupations which generally require no special training.
Service worker	All workers in service type industries.

Northern Machining & Repair III

ATTACHMENT E

DOCUMENTATION OF BENEFIT TO LOW AND MODERATE INCOME PERSONS FORM

The UGLG and Company agree that 3 FTE jobs will be created as a result of this project and at least 51% of the jobs will be held by low and moderate income persons. Income limits can be found at <http://www.huduser.gov/partners/rls/objets/rl.html>.

Each party recognizes the following:

1. If the project results in more New Jobs than expected, then the 51% requirement shall apply to the higher job number.
2. The purpose for making an application for a COBG loan is to create employment opportunities benefiting low and moderate income persons.
3. Should job creation goals for low and moderate income persons not be met, the project shall fail to qualify under the low and moderate income national objective.
4. The State retains the right to require the applicant or the company to repay the full amount of any loan funds awarded should the project fail to qualify under this National Objective.

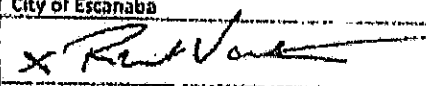
AUTHORIZED UGLG OFFICIAL	
UGLG	City of Escanaba
Signature	 Date: 8/16/18
Name and Title	Robert Valentine
Phone #: 906 786-0552	Email Address: bvalentine@escanaba.org

AUTHORIZED REPRESENTATIVE OF COMPANY	
Legal Business Name	Northern Machining & Repair
Address	1701 N 28 th St
City State Zip	Escanaba, MI. 49829
Signature	 Date: 25 Sept 18
Name and Title	Owner
Phone #: (906) 786-0526	Email Address: molleal@northernmachining.com

Site Name: MI-Escanaba-Escanaba South

Site Number: PIMI062

NB-#1

CC 11/1/18

GROUND LEASE AGREEMENT

THIS GROUND LEASE AGREEMENT (the "Lease") is made this ____ day of _____, 201__ (the "Commencement Date"), by and between the **CITY OF ESCANABA**, a Michigan Corporation ("Lessor"), and **PI TOWER DEVELOPMENT LLC**, a Delaware limited liability company ("Lessee").

1. **Leased Premises.** Lessor hereby leases to Lessee and Lessee hereby leases from Lessor under the terms and conditions set forth in this Lease a portion of that certain parcel of real property, located at **Ness Field-1619 18th Avenue South, Escanaba, MI 49829** ("Site"), as more particularly described on **Exhibit "A"** and the survey or site plan shown on **Exhibit "A-1"** attached hereto and made a part hereof ("Leased Premises"), together with an easement, or easements, for ingress, egress, utilities, fiber, and any other easements required by the local governing authorities, including, without limitation, a landscape buffer or "Fall Zone" (if applicable), for the duration of the lease on the property which is more particularly described on **Exhibit "B"** attached hereto and made a part hereof ("Easement(s)"). The easement rights herein granted include the right and authority of Lessee to grant or assign to third parties all or some of the easement rights granted to Lessee herein without additional consideration paid to Lessor. Lessor agrees and acknowledges that Lessee may, at Lessee's sole cost and expense, have a metes and bounds survey prepared of the Leased Premises and the Easement(s), and that the legal description of the Leased Premises and the Easement(s), as shown on the survey, shall thereafter become the legal description of the Leased Premises and the Easement(s). Lessor represents and warrants that Lessor has good and marketable title to the Leased Premises and the Easement(s) free and clear of all liens and encumbrances, other than those liens and encumbrances shown on **Exhibit "C"** attached hereto and made a part hereof. Lessor further represents and warrants that there are no easements, licenses, rights of use or other encumbrances on the Leased Premises or the Easement(s) which will interfere with or constructively prohibit Lessee's Intended Use (as herein defined) of the Leased Premises.

2. **Lessor's Representations and Warranties.** Lessor represents and warrants that Lessee's intended use of the Leased Premises as a site for the transmission and receipt of wireless communication signals and for the construction and maintenance of towers, antennas or buildings and related facilities ("Intended Use") is not prohibited by any covenants, restrictions, reciprocal easements, servitudes, subdivision rules or regulations. Lessor further represents and warrants that (i) the execution of this Lease by Lessor will not cause a breach or an event of default of any other agreement to which Lessor is a party, (ii) there are no pending or threatened administrative actions, including bankruptcy or insolvency proceedings under the state or federal law, suits, claims or causes of action against Lessor or which may otherwise affect the Leased Premises and the Easement(s), (iii) the Leased Premises and the Easement(s) are not presently subject to an option, lease or other contract which may adversely affect Lessor's ability to fulfill its obligations under this Lease, and (iv) Lessor shall not grant an option or enter any contract which will affect the Leased Premises or the Easement(s) until this Lease expires or is terminated by Lessee.

3. **Lessee's Due Diligence Period.**

(a) Within twenty (20) business days following the Commencement Date, Lessee shall pay to Lessor the amount of **Nine Hundred and 00/100 Dollars (\$900.00)** (the "Due Diligence Fee"), which Due Diligence Fee shall be nonrefundable to Lessee, except in the event that this Lease is terminated by Lessee prior to the Rent Commencement Date (as herein defined) due to a default by Lessor. Provided that construction of the Tower Facilities (as hereinafter defined) has not commenced, it is understood that Lessee shall have the right to terminate this Lease for any reason or no reason at all,

without any further liability or obligation to Lessor except those obligations which specifically survive the expiration or termination of this Lease, by delivery of written notice of termination to Lessor prior to the Rent Commencement Date. Lessee shall be entitled to a credit toward Rent (as hereinafter defined) due under this Lease equal to the Due Diligence Fee paid to Lessor.

(b) Lessee shall have the right, at its cost and expense, to have the Leased Premises and the Easement(s) surveyed and to obtain a title report or commitment for a leasehold title policy covering the Leased Premises and the Easement(s) from the title insurance company of its choice prior to the Rent Commencement Date. Lessor shall remove any survey or title defects, which will adversely affect Lessee's leasehold title or its ability to mortgage its leasehold interest. In the event Lessor shall fail to cure any such defects, Lessee shall have the right to terminate this Lease upon written notice to Lessor.

(c) In the event of a termination of the Lease pursuant to subparagraph 3(a) or 3(b) above or Paragraph 8 below, within thirty (30) days of such termination Lessee will file a release or other appropriate instrument with the local recording office to remove the Memorandum of Lease from the title record. If said removal is not performed by Lessee within such thirty (30) day period, Lessee appoints Lessor, as Lessee's agent and at Lessee's cost and expense, to file the necessary release or other instrument to cause the Memorandum of Lease to be released from title.

4. **Attorney-In-Fact and Cooperation.** Lessor hereby irrevocably appoints Lessee or Lessee's agent as Lessor's agent to file such applications on behalf of Lessor with federal, state and local governmental authorities which relate to Lessee's Intended Use of the Leased Premises, including, but not limited to, land use and zoning applications. Lessor agrees to cooperate with Lessee in obtaining, at Lessee's expense, all licenses and permits required for Lessee's use of the Leased Premises (the "Governmental Approval").

5. **Use.** The Leased Premises may be used by Lessee for the transmission and receipt of wireless communication signals in any and all frequencies and the construction and maintenance of a communications tower, antennas, buildings, and related facilities and activities, and all other uses permitted under applicable zoning regulations. Lessee may construct additional improvements, demolish and reconstruct improvements, or restore, replace and reconfigure improvements at any time during the Term (as herein defined) of this Lease.

6. **Initial Term.** The initial term of this Lease shall be **five (5) years** commencing on the Commencement Date and terminating on the fifth (5th) anniversary of the Commencement Date ("Initial Term"). The parties agree that a memorandum of lease in the form attached hereto as **Exhibit "D"**, evidencing the Commencement Date and other matters, shall be executed and recorded.

7. **Renewal Terms.** Lessee shall have the right to extend the Initial Term of this Lease for **five (5) additional five (5) year terms** ("Renewal Terms"). Each Renewal Term shall be on the same terms and conditions as set forth in this Lease. This Lease shall automatically be renewed for each successive Renewal Term unless Lessee notifies Lessor of Lessee's intention not to renew the Lease at least thirty (30) days prior to the expiration of the Initial Term or the Renewal Term which is then in effect. The Initial Term and each Renewal Term shall collectively be referred to herein as the "Term".

8. **Rent.** Commencing on the Rent Commencement Date, during the Term of this Lease, Lessee shall pay to Lessor an annual rental amount of Ten Thousand Eight Hundred and 00/100 Dollars (\$10,800.00), to be paid in equal monthly installments of Nine Hundred and 00/100 Dollars (\$900.00) ("Rent"), which shall be deemed to include any applicable State, County or local sales or use tax. Rent shall be payable on or before the fifteenth (15th) day of each calendar month, and shall be remitted to the address shown for Lessor in this Lease, or such other address as Lessor may direct by written notice to Lessee. Lessor acknowledges the first such payment of Rent will be made within thirty (30) days of the Rent Commencement Date. Lessee shall have no obligation to make any Rent payments until such time as Lessee receives a completed Internal Revenue Service W-9 form from Lessor, setting forth the Federal tax identification number of Lessor or the person or entity to whom the Rent checks are to be made payable

as directed in writing by Lessor (the "Tax Credentials"). From time to time during the Term and within fourteen (14) days of a written request from Lessee, Lessor agrees to provide updated Tax Credentials in a form reasonably acceptable to Lessee. The Tax Credentials shall be provided to Lessee in accordance with the provisions of, and at the address given in, Section 21 below. Within fifteen (15) days of obtaining an interest in the Property or this Lease, any assignee(s) or transferee(s) of Lessor shall provide to Lessee Tax Credentials in the manner set forth in this paragraph. The Parties acknowledge and agree that the foregoing are reasonable requirements in order to allow Lessee to comply with its legal requirements. It shall be the sole responsibility of the Lessor to remit payment of any applicable State, County or local sales, rent or use tax to the appropriate taxing authority. If the Rent Commencement Date or the date of termination (the "Termination Date") of this Lease is other than the first (1st) day of a calendar month, Rent shall be prorated. In the event of termination of this Lease for any reason, other than nonpayment of Rent, all Rent paid in advance of the Termination Date for that period shall be refunded to Lessee. The "Rent Commencement Date" shall mean the date the Lessee commences construction of the Tower Facilities; provided, however, in the event that Lessee has not commenced construction of the Tower Facilities within three (3) years following the Commencement Date, this Lease shall automatically terminate and the parties shall be released from further liability or obligation hereunder except those obligations which specifically survive the expiration or termination of this Lease. The Rent shall increase by ten percent (10%) upon the fifth (5th) anniversary of the Rent Commencement Date and every fifth (5th) year thereafter.

So long as at all times during the Initial Term and any applicable Renewal Terms there is one Wireless Carrier (as hereinafter defined) with a sublease or license from Lessee for co-location space on the Tower Facilities (the "Anchor Tenant"), then for each additional Wireless Carrier that co-locates on the Tower Facilities, other than the Anchor Tenant, the Lessee shall pay to the Lessor the Wireless Revenue Share Fee (as hereinafter defined), in monthly installments, which shall be deemed to include any applicable State, County or local sales or use tax, beginning on the date Lessee receives the additional Wireless Carrier's (other than the Anchor Tenant) rent or license fee, and, for each month thereafter for so long as the additional Wireless Carrier (other than the Anchor Tenant) pays its respective rent or license fees to Lessee. The first payment of the Wireless Revenue Share Fee shall be paid within forty five (45) days of Lessee's receipt of the first payment of rent or license fee by the additional Wireless Carrier (other than the Anchor Tenant). As used herein, the "Wireless Revenue Share Fee" shall mean an amount equal to the product of the total amount of recurring rent or license fee (excluding any reimbursement from the Wireless Carrier of taxes, utilities or other costs incurred by Lessee) paid to Lessee by the Wireless Carrier (other than Anchor Tenant) using the Tower Facilities, multiplied by fifteen percent (15%). If the date of Lessee's obligation to begin to pay the Wireless Revenue Share Fee is other than the first (1st) day of a calendar month, the Wireless Revenue Share Fee shall be pro-rated.

For the purpose of Section 8, "Wireless Carrier" shall be defined as any cellular or PCS carrier such as T-Mobile, AT&T, Cingular, Verizon, Sprint Nextel, or MetroPCS, or any 2-way/paging companies, wireless internet companies or government agencies.

9. Conditions Subsequent. In the event that Lessee's Intended Use of the Leased Premises is actually or constructively prohibited through no fault of Lessee or the Leased Premises or the Easement(s) are, in Lessee's opinion, unacceptable to Lessee, then upon notice from Lessee, this Lease shall terminate and be of no further force or effect and Lessee shall be entitled to a refund from Lessor of any deposits or Rent paid in advance to Lessor.

10. Interference. Lessor shall not use, nor shall Lessor permit its lessees, licensees, invitees or agents to use, any portion of adjacent real property owned by Lessor in any way which interferes with the wireless communications operation of Lessee. Such interference shall be deemed a material breach of this Lease by Lessor and Lessor shall have the responsibility to terminate said interference at its sole cost and expense. In the event any such interference does not cease or is not promptly rectified, Lessor acknowledges that continuing interference will cause irreparable injury to Lessee, and Lessee shall have the right, in addition to any other rights that it may have at law or in equity, to bring action to enjoin such interference or to terminate this Lease immediately upon notice to Lessor.

11. Improvements; Utilities, Access and Other Easements.

(a) Lessee shall have the right at Lessee's sole cost and expense, to erect and maintain on the Leased Premises improvements, personal property and facilities, including without limitation, a communications tower, a structural tower base, radio transmitting and receiving antennas, communications equipment, equipment cabinet and/or shelters, and related facilities (collectively the "Tower Facilities"). The Tower Facilities shall remain the exclusive property of the Lessee throughout the Term and upon termination of this Lease. All or any portion of the Tower Facilities may be removed by the Lessee from the Leased Premises at any time during the Term. Lessee shall, upon expiration of the Term, or within ninety (90) days after any earlier termination of the Lease, remove its building(s), antenna structure(s) (including footings to a depth of no less than 3' below the surface), equipment, conduits, fixtures and all personal property placed thereon by or through Lessee and restore the Leased Premises to their original condition, reasonable wear and tear and casualty damage excepted. Lessor grants Lessee the right to clear all trees, undergrowth, or other obstructions and to trim, cut, and keep trimmed and cut all tree limbs which may interfere with or fall upon Lessee's tower or Lessee's other improvements, communications equipment, or Easement rights. Lessor grants Lessee a non-exclusive easement in, over, across and through other real property owned by Lessor as reasonably required for construction, installation, maintenance, and operation of the Tower Facilities. The Lessor agrees that any property of the Lessee that remains on the Leased Premises after ninety (90) days following the expiration or earlier termination of this Lease shall be deemed abandoned by the Lessee and shall be thereafter owned by the Lessor without further consent of the Lessee.

(b) Lessee shall have the right to install utilities, and/or fiber, at Lessee's expense, and to improve present utilities on the Leased Premises (including but not limited to the installation of emergency power generators). Lessee shall have the right to permanently place utilities or fiber on (or to bring utilities or fiber across or under) the Easement(s) to service the Leased Premises and the Tower Facilities. In the event that utilities or fiber are necessary to serve the equipment of Lessee or the equipment of Lessee's licensee(s) or sublessee(s) cannot be located within the Easement(s) for ingress and egress, Lessor agrees to cooperate with Lessee and to act reasonably in allowing the location of utilities or fiber on other real property owned by Lessor without requiring additional compensation from Lessee or Lessee's licensee(s) or sublessee(s). Lessor shall, upon Lessee's request, execute a separate written easement to the utility or fiber company providing the service for Lessee in a form which may be filed of record evidencing this right.

(c) Lessor represents and warrants to Lessee that Lessee shall, at all times during this Lease, enjoy ingress, egress, and access from the Leased Premises to an open and improved public road which presently exists, and which Easement(s) shall be adequate to service the Leased Premises and the Tower Facilities. If no such public road exists, or ceases to exist in the future, Lessor will grant an appropriate easement to Lessee and its sublessees and assigns so that Lessee may, at its own expense, construct a suitable private access drive to the Leased Premises and the Tower Facilities. Lessor acknowledges and agrees that any new private access drive constructed by Lessee will be used exclusively by Lessee and its sublessees, sublicensees and assigns. Any use thereof by Lessor, its tenants, licensees, or lessees or other occupants on the Site shall be subject to Lessee's prior written consent to use such private access drive. Any attempted use thereof by Lessor, its tenants, licensees or lessees or other occupants of the Site without Lessee's prior written consent shall be considered a material breach of this Lease. To the extent such access is across other property owned by Lessor, Lessor shall execute an easement evidencing this right and Lessor shall maintain access to the Easement(s) in a free and open condition so that no interference is caused by Lessor or by other lessees, licensees, invitees or agents of the Lessor which may utilize the Easement(s). Lessor shall provide such access to the Leased Premises across Lessor's adjacent property, and over all paved or unpaved roads owned or controlled by Lessor, to allow Lessee, or its sublessees, to use, maintain and repair the improvements located on the Leased Premises. Such access shall be provided twenty-four (24) hours per day, seven (7) days per week.

(d) If governmental authorities require a landscape buffer easement or any other type of easement to grant approval for the construction of the Tower Facilities ("Additional Easement(s)"), and if such Additional Easements cannot be located within the Leased Premises or the Easement(s) for ingress and egress, Lessor agrees to cooperate with Lessee and to act reasonably in allowing the location of such

Additional Easement(s) on other real property owned by Lessor without requiring additional compensation from Lessee or Lessee's licensee(s) or sublessee(s). Lessor shall, upon Lessee's request, execute a separate written easement for such Additional Easement(s) in a form which may be filed of record evidencing this right.

12. Replacement and Installation of Tower. Lessee agrees that it shall remove and dispose of the existing light pole owned by Lessor as described in Exhibit A-1 attached hereto ("Existing Pole") located at the Property. Prior to the removal of the Existing Pole, Lessee shall remove Lessor's existing athletic lights ("Lights") from the Existing Pole and place them on the tower, at the location described on Exhibit A attached hereto, to be constructed by Lessee at the Property ("Tower"). Lessee agrees that the removal and disposal of the Existing Pole and removal and reinstallation of the Lights on the Tower shall be at the sole cost and expense of Lessee. Lessee agrees that the placement of the Lights on the Tower shall be as additional consideration for Lessee's use of the Property and Lessor shall not be required to pay rent to Lessee for the use of such space on the Tower. Lessor shall be solely responsible for the maintenance, repair and replacement of the Lights and the cost of the electrical power for the Lights. Lessor agrees to maintain the Lights in good condition and repair and in compliance with all applicable laws, rules and regulations. Lessor agrees that all construction, maintenance, removal or alteration of Lessor's Lights shall be coordinated with and approved by Lessee and any modifications thereto may require a structural analysis, the cost of which shall be paid by Lessor.

13. Conveyance of Tower to Lessor. After the Tower is installed, upon expiration or the earlier termination of this Lease, Lessor may elect to take ownership of the Tower by providing written notice to Lessee within thirty (30) days of the expiration or termination of the Lease. After receipt of notice by Lessee of Lessor's election to take ownership of the Tower and within ninety (90) days of said notice, Lessee shall transfer title to the Tower to the Lessor. Lessor agrees that it shall accept the Tower in "AS IS" condition. Lessee shall deliver an executed bill of sale to the Lessor transferring title to the Tower to Lessor. The Lessor shall accept the conveyance of the Tower without any warranties, representations or guaranties, either express or implied, of any kind, nature or type whatsoever, from or on behalf of the Lessee with respect to the personal property, including, without limitation, the physical condition of the Tower.

14. Termination. Except as otherwise provided herein, this Lease may be terminated without any penalty or further liability upon written notice as follows:

(a) By either party upon a default of any covenant or term hereof by the other party, which default is not cured within sixty (60) days of receipt of written notice of default (without however, limiting any other rights available to the parties pursuant to any other provisions hereof); provided, that if the defaulting party commences efforts to cure the default within such period and diligently pursues curing of the default to completion within a reasonable time period, the non-defaulting party shall no longer be entitled to declare a default;

(b) Upon thirty (30) days' written notice by Lessee to Lessor, if Lessee is unable to obtain or maintain through no fault of Lessee, any license, permit or other Governmental Approval necessary for the construction and operation of the Tower Facilities or Lessee's business; or

(c) By Lessee for any reason upon one (1) year's advance written notice from Lessee to Lessor; or

(d) By Lessee pursuant to Paragraph 3 of this Lease.

15. Sublessee's Improvements. Lessee's licensee(s) and sublessee(s) shall be entitled to modify the Tower Facilities and to erect additional improvements on the Leased Premises, including, but not limited to antennas, dishes, cabling, additional storage buildings or equipment shelters as are reasonably required for the operation and maintenance of the communications equipment, together with rights of ingress and egress to the Leased Premises and the right to install utilities and fiber to and on the Leased Premises and Easement(s) as if said licensee or sublessee were the Lessee under this Lease.

16. Taxes. Lessee shall pay any personal property taxes assessed on, or any portion of such taxes attributable to, the Tower Facilities. Lessee shall pay, as additional Rent, any increase in real property taxes levied against the Leased Premises which are directly attributable to Lessee's use of the Leased Premises (the "Telecom Increase") within thirty (30) days of receipt of Lessor's written request provided that Lessor agrees to furnish proof of the Telecom Increase to Lessee within ninety (90) days from the issuance of the tax bill from the local taxing authority. If the Lessor fails to provide Lessee with such proof of the Telecom Increase within ninety (90) days of the issuance of the tax bill from the local taxing authority, then Lessee shall have no obligation to reimburse Lessor for, or to pay such Telecom Increase. In the event that Lessor fails to pay, when due, any taxes affecting the Leased Premises or the Easement(s), Lessee shall have the right, but not the obligation, to pay such taxes and deduct the full amount of the taxes paid by Lessee on Lessor's behalf from future installments of Rent. Lessor hereby represents and warrants that Lessor's property on which the Leased Premises and Easement(s) are located is not subject to any "Conservation Use Covenant", "Greenbelt Covenant", agricultural or timberland covenant, or any other conservation use program which restricts or limits development of Lessor's property. Lessor agrees to be solely responsible for payment of any penalties, roll-back or additional taxes, special assessments or other monetary amounts now or hereafter payable to any county, city, state or other party as a result of the breach of any conservation use tax program affecting the property on which the Leased Premises and Easement(s) are located or resulting from the change in the nature or character of the use of the property from its present use to a communications tower facility. Lessor does hereby covenant and agree to indemnify, defend and hold Lessee forever harmless from any and all liabilities, claims, demands, actions or causes of action arising from or relating to a breach of any such covenants, whether such breach occurs because of the erection of the Tower Facilities on the Leased Premises or otherwise.

17. Destruction of Premises. If the Leased Premises or the Tower Facilities are destroyed or damaged, so as to hinder the effective use of the Tower Facilities in Lessee's judgment, Lessee may elect to terminate this Lease as of the date of the damage or destruction by so notifying the Lessor. In such event, all rights and obligations of Lessee to Lessor shall cease as of the date of the damage or destruction, and Lessee shall be entitled to the reimbursement of any Rent prepaid by the Lessee.

18. Condemnation. If a condemning authority takes all of the Leased Premises or Easement(s), or a portion sufficient in Lessee's determination to render the Leased Premises or the Easement(s), in the opinion of Lessee, unsuitable for the use which Lessee was then making of the Leased Premises and Easement(s), this Lease shall terminate as of the date the title vests in the condemning authority. Lessee shall be entitled to file its own claims against the condemning authority for the value of its Tower Facilities, moving expenses, prepaid rent and business dislocation expenses. A sale of all or part of the Leased Premises and/or Easement(s) to a purchaser with the power of eminent domain, in the face of the exercise of eminent domain power, shall be treated as taking by condemnation for the purpose of this paragraph.

19. Insurance. Lessee shall purchase and maintain in full force and effect throughout the Term, public liability and property damage policies. The policy of general liability insurance shall provide a combined single limit of \$1,000,000 and shall name Lessor as an additional insured.

20. Lessee's Environmental Covenants and Indemnity. As used in this Lease, the term "Hazardous Materials" shall mean any hazardous or toxic substance, material or waste which is, or becomes designated as such in the future or is regulated by any agency of the United States Government or by any local governmental authority having jurisdiction, including, without limitation, any substance, material or waste that is defined or designated as a hazardous substance pursuant to the Comprehensive Environmental Response, Compensation and Liability Act, the Resource Conservation and Recovery Act or the Clean Water Act. During the Term of this Lease, Lessee shall cause the presence, use, storage and/or disposal of any Hazardous Material, on or under the Leased Premises by Lessee, its agents, employees, business invitees, contractors or sublessees to be in compliance with all applicable laws, rules, regulations and orders. Lessee shall not install or permit the installation of any underground storage tanks on the Leased Premises. Lessee shall defend, indemnify, protect and hold Lessor harmless from and against all claims, costs, fines, judgments and liabilities, including, without limitation, reasonable attorney's fees and costs, arising out of or in connection with the presence, storage, use or disposal of Hazardous

Materials on or under the Leased Premises to the extent caused by the acts, omissions or negligence of Lessee, its employees, business invitees, contractors or sublessees. The foregoing indemnity shall survive the expiration or earlier termination of this Lease.

21. Lessor's Environmental Representation and Indemnity. Lessor represents and warrants that no Hazardous Materials have been generated, stored, disposed of or are present on or under the Leased Premises and the Easement(s) prior to the Commencement Date of this Lease. Lessor shall indemnify, defend, protect and hold Lessee harmless from and against any and all claims, costs, fines, judgments, liability, actions, causes of action, liens and expenses, including, without limitation, penalties and reasonable attorneys' fees, incurred or suffered by or asserted against Lessee, to the extent arising out of or in any way relating to any one or more of the following which are not caused by Lessee: (a) the presence of any Hazardous Materials in, on, or under the Leased Premises; (b) any past, present or threatened release of Hazardous Materials in, on, under or from the Leased Premises; (c) any activity by Lessor in connection with any actual, proposed or threatened use, treatment, storage, existence, disposition or other release, production, manufacturing, management, abatement, removal, handling, transfer or transportation to or from the Leased Premises of any Hazardous Materials at any time located in, under or on the Leased Premises; (d) any testing and/or remediation costs in connection with any Hazardous Materials alleged to be located in, under, on or above the Leased Premises; (e) any past or present non-compliance with or violations of any environmental laws in connection with the Leased Premises or operations thereon, including but not limited to, any failure by Lessor to comply with any order of any governmental authority in connection with any environmental laws; and (f) the imposition, recording or filing or the threatened imposition, recording or filing of any environmental lien encumbering the Leased Premises. The foregoing representations and indemnities shall survive the expiration or earlier termination of this Lease.

22. Mutual Indemnification. Lessor shall indemnify and hold harmless Lessee from and against any and all claims, liabilities, loss or damage, penalties or judgments to the extent arising from injury to person or property sustained by anyone in and about the Leased Premises and Easement(s) resulting from any act(s) or omissions(s) of Lessor, or Lessor's officers, agents, servants, employees, contractors, or sublessees. Further, Lessor shall, at its own cost and expense, defend any and all suits or actions (just or unjust) which may be brought against Lessee or in which Lessee may be impleaded with others upon any such matter, claim or claims, except as may result from the acts described in the following paragraph. This indemnification obligation shall survive the expiration or earlier termination of the Lease.

Lessee shall indemnify and hold harmless Lessor from and against any and all claims, liabilities, loss or damage, penalties or judgments to the extent arising from injury to person or property sustained by anyone in and about the Leased Premises and Easement(s) resulting from any act(s) or omissions(s) of Lessee, or Lessee's officers, agents, servants, employees, contractors, or sublessees. Further, Lessee shall, at its own cost and expense, defend any and all suits or actions (just or unjust) which may be brought against Lessor or in which Lessor may be impleaded with others upon any such matter, claim or claims, except as may result from the acts described in the preceding paragraph. This indemnification obligation shall survive the expiration or earlier termination of the Lease.

23. Notices. All notices required or permitted under this Agreement shall be in writing and shall be deemed effective upon personal delivery, or three (3) days after being deposited in the U.S. Mail, registered or certified, and postage prepaid, or one (1) day after being deposited with a recognized overnight delivery service. Such notices shall be addressed to the applicable party at its address shown below, or at such other address or addresses as either party shall designate to the other in writing in accordance with this paragraph:

As to Lessor:

City of Escanaba
Attn: City Controller
410 Ludington Street
Escanaba, MI 49829
Phone: (906) 786-0605

E-mail address: N/A

As to Lessee: PI Tower Development LLC c/o Lendlease (US) Telecom Holdings LLC
909 Lake Carolyn Parkway
Suite 260
Irving, Texas 75039
Attention: Corporate Contracts Manager

With a copy to: Lendlease Americas, Inc.
200 Park Avenue
9th Floor
New York, New York 10166
Attention: General Counsel

24. Title and Quiet Enjoyment. Lessor warrants and represents that (i) it has the full right, power, and authority to execute this Lease; (ii) it has good and marketable fee simple title to the Leased Premises and the Easement(s); and (iii) the Leased Premises constitute a legal lot that may be leased without the need for any subdivision or platting approval. Lessor covenants that Lessee shall have the quiet enjoyment of the Leased Premises during the Term of the Lease. Lessor shall indemnify, defend and hold harmless Lessee from and against any loss, cost, expense or damage, including attorneys fees associated with a breach of the foregoing covenant of quiet enjoyment. This Lease shall be an estate for years and not a usufruct. Lessor shall not use, nor shall Lessor permit its lessees, licensees, invitees, or agents to use any portion of any property owned or controlled by Lessor in any way which interferes with the operations of Lessee. Such interference shall be deemed a material breach by Lessor, and Lessee shall have the right, in addition to any other rights that it may have in law or equity, to enjoin such interference or to terminate this Lease.

25. Subordination and Non-Disturbance. This Lease shall be subject to and subordinate to any mortgage or deed to secure debt (collectively referred to as a "Mortgage") made by Lessor which may now or hereafter encumber the Leased Premises and Easement(s), provided that no such subordination shall be effective unless the holder of every such Mortgage shall in a separate agreement with Lessee agree that in the event of a foreclosure, or conveyance in lieu of foreclosure of Lessor's interest in the Leased Premises and Easement(s), such holder shall recognize and confirm the validity and existence of this Lease and that Lessee shall have the right to continue its use and occupancy of the Leased Premises and Easement(s) in accordance with the provisions of this Lease as long as Lessee is not in default of this Lease beyond applicable notice and cure periods. Lessee shall execute in timely fashion such instruments as may reasonably be requested to evidence the provisions of this paragraph. In the event the Leased Premises and/or Easement(s) are encumbered by a Mortgage on the Commencement Date, Lessor, no later than ten (10) days after the Commencement Date, shall obtain and furnish Lessee with a non-disturbance agreement in recordable form from the holder of each Mortgage.

26. Assignments and Subleases.

(a) Lessee may, upon notice to Lessor, mortgage or grant a security interest in Lessee's leasehold estate and the Tower Facilities, and may make a conditional assignment of this Lease and the Tower Facilities to any such mortgagees or holders of security interests, including their successors and assigns (hereinafter, collectively referred to as "Secured Parties"). In such event, Lessor shall execute such consent to leasehold financing as may reasonably be required by any Secured Party. Lessor agrees to notify Lessee and Lessee's Secured Parties simultaneously of any default by Lessee, and to give to the Secured Parties the same right to cure any default as Lessee except that the cure period for any Secured Party shall not be less than thirty (30) days after the receipt of the default notice; provided, however, that for non-monetary defaults, Lessor shall not terminate the Lease for so long as a Secured Party is diligently pursuing a cure of the default, and if curing such non-monetary default requires possession of the Leased

Premises and Easement(s), then Lessor agrees to give Secured Party a reasonable time to obtain possession of the Leased Premises and Easement(s) and to cure such default. If a termination, disaffirmation or rejection of the Lease, pursuant to any laws (including any bankruptcy or insolvency laws), by Lessee shall occur, or if Lessor shall terminate this Lease for any reason as provided for in Paragraph 12, herein, Lessor will give the Secured Parties prompt notice thereof and Lessor will give each Secured Party the right to enter upon the Leased Premises during a thirty (30) day period commencing upon such Secured Party's receipt of such notice for the purpose of removing any Tower Facilities. In addition, if this Lease is terminated for any reason, or otherwise rejected in bankruptcy, Lessor shall, upon request, enter into a new lease with a Secured Party on the same terms as those contained in this Lease provided such Secured Party pays all past due amounts within thirty (30) days of notice of such termination. Lessor waives any lien, interest, claim, right or title in the Tower Facilities which Lessor now has or may hereafter acquire, whether by statute, agreement or otherwise, and agrees that the Tower Facilities shall remain personal property and shall not constitute fixtures, notwithstanding any attachment to real property or any other applicable law or doctrine relating to fixtures. A Secured Party shall have all of the rights of Lessee under the Lease, including, but not limited to, the right to exercise any renewal option(s) or purchase option(s) set forth in this Lease. Lessor acknowledges that the Secured Parties shall be third-party beneficiaries of this Lease.

(b) Lessee shall, upon notice to Lessor, have the right to license, sublease or assign its rights under this Lease, without the consent of Lessor, upon any of the following conditions:

- i. any conditional assignment of this Lease to a Secured Party as described in subparagraph (a) above;
- ii. any license or sublease of a portion of the Leased Premises and the Tower Facilities in the ordinary course of Lessee's business;
- iii. an assignment or sublease to an affiliate entity of Lessee; or
- iv. an assignment to an entity in the business of developing or owning telecommunication towers, provided that any such assignee shall have a net worth equal to or greater than Lessee's at the time of any such assignment.

Any license, sublease or assignment by Lessee of its rights under this Lease which is not set forth in (i) – (iv) above shall require the consent of the Lessor, which consent shall not be unreasonably withheld, delayed and/or conditioned. Any license, sublease or assignment pursuant to this subparagraph (b) shall be subject to all terms and conditions of this Lease. Upon assignment of all of its rights pursuant to this Lease, and the execution of a written assumption of all of the terms and conditions of the Lease by the assignee, Lessee shall be released from any further liability under this Lease.

Lessor shall have the right to assign or otherwise transfer this Lease and the Easement(s) granted herein, upon written notice to Lessee, but only in connection with the simultaneous sale or transfer Lessor's entire right, title and interest in the Site. Any assignment or transfer of this Lease which is separate and distinct from a transfer of Lessor's entire right, title and interest in the Site shall require the prior written consent of Lessee which may be withheld in Lessee's sole discretion.

27. Successors and Assigns. This Lease shall run with the Leased Premises described on **Exhibit "A"** and shall be binding upon and inure to the benefit of the parties, their respective heirs, successors, personal representatives and assigns.

28. Waiver of Lessor's Lien. Lessor hereby waives any and all lien rights it may have, statutory or otherwise, in and to the Tower Facilities or any portion thereof, regardless of whether or not same is deemed real or personal property under applicable laws.

29. Waiver of Incidental and Consequential Damages. Lessor will not assert any claim whatsoever against Lessee for loss of anticipatory profits or any other indirect, special, incidental or

consequential damages incurred by Lessor as a result of the construction, maintenance, operation or use of the Leased Premises or the Easement(s) by Lessee.

30. Lessee's Exclusivity. Lessor agrees not to lease any of Lessor's property within a radius of one (1) mile from the Leased Premises for construction of a tower, for the construction or for use as a communications facility or for the operation of an antenna site leasing business which competes directly or indirectly with Lessee.

31. Right of First Refusal. In the event that the Lessor receives and desires to accept a bona fide offer to sell and convey the Leased Premises to a third party not related to the Lessor by at least 51% common ownership, then the Lessor shall first provide the Lessee with a written offer to sell and convey the Leased Premises to Lessee upon the same terms and conditions as the offer made by the third party. The notice to Lessee shall include a copy of the third party's offer. If the third party offer is to purchase assets in addition to the Leased Premises, the right of first refusal hereunder shall apply only to the Leased Premises and the Lessor shall provide to Lessee the only the terms of the third party's offer which are applicable thereto. Lessee shall have twenty (20) business days from the receipt from the Lessor's notice to accept the offer to purchase the Leased Premises. If Lessee desires to accept the offer, it shall notify the Lessor in writing within the said twenty (20) business day period and closing thereon shall occur within ninety (90) days of the date of Lessee's written acceptance of the offer. Transfer of title shall be by Special Warranty Deed and a Bill of Sale that warrants title to the Leased Premises without exception or encumbrance. If Lessee does not elect to accept the offer to purchase the Leased Premises, then the Lessor may proceed with selling the Leased Premises to the third party upon the same terms and conditions as offered to Lessee, which sale shall be made subject to the terms of this Lease. Should the third party not complete the purchase transaction, then this Right of First Refusal shall continue in effect for any future offers received by the Lessor.

32. Certifications. Either party may request, in writing, that the other party certify information to a prospective mortgagee or purchaser. Such certification shall be transmitted within ten (10) days after receipt of written request and may be relied upon by the party who requested it, and the contents of the certificate shall be binding upon the party executing it. The certificate may include (i) the validity, force and effect of this Lease; (ii) the extent to which this Lease has been supplemented or amended; (iii) the existence of any default; (iv) the existence of any offsets, counter-claims or defenses on the part of the other party; (v) the commencement and expiration dates of the Term, (vi) the amount of any prepaid rent; and (vii) any other matter as may reasonably be requested.

33. Self Help. Without limiting Lessee's right to terminate this Lease pursuant to Paragraph 12(a) hereof, in case of a breach of any covenant or term hereof by the Lessor, the Lessee may, in its sole discretion, elect to remedy the Lessor's breach, which remedy shall not operate or be construed as a waiver of the Lessee's rights herein to recover the cost of such remedy from the Lessor by setoff or otherwise, and the Lessor shall indemnify the Lessee from any and all costs, expenses, reasonable attorney fees and litigation expenses as may be incurred by the Lessee in performing the Lessor's obligations hereunder.

34. Restrictive Covenants. Lessor acknowledges and agrees that this Lease and the rights granted herein to Lessee are integral to the Rent paid by Lessee to Lessor, and that Lessee would not have agreed to pay such monetary consideration to Lessor if Lessor were to create circumstances that would compete with the rights of Lessee and its intended business operations. Accordingly, Lessor agrees that, for so long as this Lease is in effect, Lessor shall not enter into a lease, license, or other agreement whereby Lessor (i) transfers its' beneficial rights in this Lease to a third party without such third party purchasing Lessor's right, title and interest in the entire Site, (ii) transfers the rights to use or operate any portion of the Site to a third party for the operation of wireless telecommunications equipment, except, Lessor may grant the Easements contemplated herein or other easements for customary utilities, or (iii) authorizes the construction of any wireless telecommunications towers or structures on the Site for the use by unaffiliated third parties to operate such wireless telecommunications towers or structures for profit. Any actions of Lessor as set forth in (i), (ii) or (iii) shall be considered a material breach of this Lease. In case of a breach by Lessor of the covenants contained in this Section 32, Lessee will be irreparably damaged and shall be entitled (in addition to any other remedy to which it may be entitled in law or in

equity) to injunctive relief to enforce Lessor's obligations herein.

35. Miscellaneous.

(a) The substantially prevailing party in any litigation arising hereunder shall be entitled to its reasonable attorney's fees and court costs, including appeals and post-judgment proceedings, if any.

(b) Each party agrees to furnish to the other, within ten (10) days after request, such truthful estoppel information as the other may reasonably request.

(c) This Lease constitutes the entire agreement and understanding of Lessor and Lessee with respect to the subject matter of this Lease, and supersedes all offers, negotiations and other agreements. There are no representations or understandings of any kind not set forth herein. Any amendments to this Lease must be in writing and executed by Lessor and Lessee; provided, however, that this Lease may not be amended in any respect which would be reasonably likely to have a material adverse effect on a Secured Party's interest therein, or surrendered, terminated or cancelled by Lessee, without the prior written consent of such Secured Party.

(d) If either Lessor or Lessee is represented by a broker in this transaction, that party shall be fully responsible for any fees due such broker and shall hold the other party harmless from any claims for commission by such broker.

(e) This Lease shall be construed in accordance with the laws of the state in which the Leased Premises is situated.

(f) If any term of this Lease is found to be void or invalid, such invalidity shall not affect the remaining terms of this Lease, which shall continue in full force and effect.

(g) Lessor shall cooperate with Lessee in executing any documents necessary to protect Lessee's rights under this Lease or Lessee's use of the Leased Premises and the Easement(s), and to take such action as Lessee may reasonably require to effect the intent of this Lease.

(h) This Lease may be executed in two or more counterparts, all of which shall be considered one and the same agreement and shall become effective when one or more counterparts have been signed by each of the parties, it being understood that all parties need not sign the same counterpart. The parties agree that a scanned or electronically reproduced copy or image of this Lease shall be deemed an original.

(SIGNATURE PAGES FOLLOWING)

IN WITNESS WHEREOF, the parties hereto have executed this Lease as of the date first written above.

WITNESS:

Print Name

Print Name

Print Name

Print Name

LESSOR:

**City of Escanaba,
a Michigan Corporation**

By: _____

Name: _____

Title: Mayor

Date: _____

By: _____

Name: _____

Title: Clerk

Date: _____

LESSEE:

**PI TOWER DEVELOPMENT LLC,
a Delaware limited liability company**

WITNESS:

Print Name

Print Name

By: _____

Print Name: _____

Title: _____

Date: _____

EXHIBIT "A"

Description of Real Property (Leased Premises)

A **30' by 60'** parcel of land for the tower compound being located around the base of the tower, all being a portion of the parent tract (see attached warranty deed for legal description of parent tract, if available). The legal description of the Leased Premises shall be determined by survey and shall thereafter replace this **Exhibit "A"**.

Tax Parcel I.D. # of parent tract: 051-420-3606-100-015

Physical Address of parent tract: Ness Field
1619 18th Avenue South
Escanaba, MI 49829

EXHIBIT "A-1"

Survey or Site Plan

Location of the Leased Premises shall be determined by survey, and upon completion shall replace this **Exhibit "A-1"**.

EXHIBIT "B"

Easement(s)

(i) An easement from the Leased Premises to an open and improved public road in a minimum width of either 30 feet or the minimum width necessary to comply with any applicable governmental requirements, whichever is greater, to allow for ingress to and egress from the Leased Premises by vehicle;

(ii) An easement as may be required to provide utilities and/or fiber to the Leased Premises from the utility providers' preferred connection point;

(iii) if required by governmental authorities, an easement for a "Fall Zone" centered on the location of the Lessee's tower and extending outward in a circle for the number of feet as may be required by local zoning authorities (typically equal to the height of the Lessee's tower but could be more); and

(iv) if required by governmental authorities, an easement for a landscape buffer zone or any such additional easement(s) as may be required by local zoning authorities,

each to be determined by survey, and upon completion of survey, shall replace this **Exhibit "B"**.

EXHIBIT "C"

Liens and Encumbrances

Holder of 1st Mortgage: _____
Address: _____
Contact Name: _____
Phone Number: _____
Loan Number: _____

Holder of 2nd Mortgage: _____
Address: _____
Contact Name: _____
Phone Number: _____
Loan Number: _____

Other Liens/Encumbrances
(Please Describe): _____

If No Mortgage(s), check here: _____

EXHIBIT "D"

MEMORANDUM OF GROUND LEASE AGREEMENT

See Attached

Upon recording return to:

PI Tower Development LLC
909 Lake Carolyn Parkway, Suite 260
Irving, Texas 75039
Attention: Corporate Contracts Manager

Site Name: MI-Escanaba-Escanaba South
Site Number: PIMI062

MEMORANDUM OF GROUND LEASE AGREEMENT

This Memorandum of Ground Lease Agreement is made on _____, 201__, by and between the **CITY OF ESCANABA**, a Michigan corporation, as Lessor, whose mailing address is 410 Ludington Street, P.O. Box 948, Escanaba, MI 49829 and **PI TOWER DEVELOPMENT LLC**, a Delaware limited liability company, as Lessee, whose address is 909 Lake Carolyn Parkway, Suite 260, Irving, Texas 75039.

1. Lessor and Lessee are parties to a Ground Lease Agreement dated as of _____, 201__ (the "Lease"), the terms and provisions of which are incorporated herein by this reference. The premises covered by the Lease are located in **Delta County, Michigan**, as more fully described in the legal description attached hereto as **Exhibit "A"** ("Leased Premises").
2. Pursuant to the Lease, the Lessor has granted, and by these presents does grant, to the Lessee easements for ingress, egress, utilities, fiber, "Fall Zone" (if applicable), and any other easements required by Lessee or governmental authorities for the duration of the Lease Agreement a more particularly described on **Exhibit "A"** hereto. The easement rights herein granted include the right and authority of Lessee to grant or assign to third parties all or some of the easement rights granted to Lessee herein.
3. The Lease provides for an initial term of five (5) years (the "Initial Term") which commenced on _____. The Lease also provides for five (5) additional five (5) year renewal terms (each, a "Renewal Term"). The Lease shall automatically renew for each such Renewal Term unless Lessee delivers written notice of intent not to renew to Lessor at least thirty (30) days prior to the expiration of the Initial Term, or the Renewal Term then in effect.
4. The Lease provides that during the term of the Lease neither Lessor nor any tenant or person or entity claiming by or through Lessor shall be allowed to install or operate a communications facility, including a telecommunications transmission tower, or operate an antenna site leasing business which competes directly or indirectly with Lessee on the lands of Lessor within a radius of one (1) mile of the Leased Premises.
5. The Lease provides that during the term of the Lease, in the event that the Lessor receives and desires to accept a bona fide offer to sell and convey the Leased Premises to a third party not related to the Lessor by at least 51% common ownership, then the Lessor shall first provide the Lessee with a written offer to sell and convey the Leased Premises to Lessee upon the same terms and conditions as the offer made by the third party, and Lessee shall have twenty (20) business days in which to accept the offer.
6. The Lease provides that during the term of the Lease, Lessor shall not enter into a lease, license, or other agreement whereby Lessor (i) transfers its beneficial rights in this Lease to a third party without such third party purchasing Lessor's right, title and interest in the entire Site, (ii) transfers the rights to use or operate any portion of the Site to a third party for the operation of wireless telecommunications equipment, or (iii) authorizes the construction of any wireless telecommunications towers or structures on the Site, for Lessor's own use, or for the use of any unaffiliated third parties.

7. All of the terms and conditions of the Lease are incorporated herein by reference. In the event of a conflict between the terms hereof and the terms of the Lease, the terms of the Lease shall govern.

IN WITNESS WHEREOF, the parties hereto have executed this Memorandum of Lease as of the date first written above.

LESSOR:

EXHIBIT ONLY - DO NOT SIGN

a _____

Witness:

Print Name: _____

Title: _____

Print Name: _____

Print Name: _____

STATE OF _____

COUNTY OF _____

I, _____ a Notary Public of the County and State aforesaid, certify that _____, as _____ of _____, a _____ personally came before me this day and acknowledged that (s)he executed the foregoing instrument on behalf of said _____. He/She is personally known to me or produced _____ as identification.

WITNESS my hand and notarial seal, this ____ day of _____, 201__.

Notary Public: _____

Print Name: _____

(affix notary stamp/seal)

My Commission Expires: _____

LESSEE:

PI TOWER DEVELOPMENT LLC,
a Delaware limited liability company

Witness:

Print Name: _____

Print Name: _____

EXHIBIT ONLY - DO NOT SIGN

Print Name: _____

Title: _____

STATE OF FLORIDA

COUNTY OF _____

I, _____ the undersigned Notary Public for said County and State, do hereby certify that _____, as _____ of PI Tower Development LLC, a Delaware limited liability company, personally appeared before me this day, and acknowledged the due execution of the foregoing instrument on behalf of said company. He/She is personally known to me or produced _____ as identification.

WITNESS my hand and notarial seal, this ____ day of _____, 201__.

Notary Public: _____

Print Name: _____

{affix notary stamp/seal}

My Commission Expires: _____

EXHIBIT "A"

LEASED PREMISES AND EASEMENTS

The 30' x 60' Leased Premises and Easement(s) are located in the land legally described as follows: