

Appendix A

**OFFICIAL PROCEEDINGS
CITY COUNCIL
CITY OF ESCANABA, MICHIGAN
Regular Council Meeting
Thursday, December 16, 2021**



Mark Ammel, Mayor
Karen Moore, Mayor Pro Tem
Ronald J. Beauchamp, Council Member
Tyler DuBord, Council Member
Todd Flath, Council Member

**CITY COUNCIL
MEETING AGENDA
December 16, 2021**

Patrick S. Jordan, City Manager
Phil DeMay, City Clerk
John Bergman, City Attorney

City Council Chambers located at: City Hall – 410 Ludington Street – Room C101 – Escanaba, MI 49829

The Council has adopted a policy to use a Consent Agenda, when appropriate. All items with an asterisk (*) are considered routine by the City Council and will be enacted by one motion. There will be no separate discussion of these items unless a Council Member or citizen so requests, in which event, the item will be removed from the General Order of Business and considered in its normal sequence on the Agenda.

Regular Meeting
Thursday, December 16, 2021, at 7:00 p.m.

CALL TO ORDER
ROLL CALL
INVOCATION/PLEDGE OF ALLEGIANCE
APPROVAL/CORRECTION(S) TO MINUTES – Regular Meeting – December 2, 2021
APPROVAL/ADJUSTMENTS TO THE AGENDA
CONFLICT OF INTEREST DECLARATION(S)
BRIEF PUBLIC COMMENT(S)
PUBLIC HEARINGS – None
UNFINISHED BUSINESS – None
NEW BUSINESS

- 1. Approval and Adoption – Five-Year Recreation Plan – Recreation.**
Explanation: The Recreation Advisory Board held a Public Hearing and approved a resolution on the draft Five-Year Recreation Plan on November 9, 2021. The Recreation Advisory Board is recommending to City Council the approval and adoption of the Five-Year Recreation Plan. A resolution will need to be passed by the City Council.
- 2. Approval – Lease Amendments between Bay College and the City of Escanaba – Recreation.**
Explanation: Administration is seeking City Council approval on two lease amendments between Bay de Noc Community College and the City of Escanaba.
- 3. Approval – Contract with CUPPAD – Public Works.**
Explanation: Administration is seeking City Council approval for a contract with CUPPAD in the amount of \$2,700. CUPPAD will assist the City in developing a site plan and visualization of the inner harbor walkway with integrated fishing piers in Ludington Park.
- 4. Closed Session – Discussion with Bernstein Law Group on Settlement Agreements on Opioid Suit – Administration.**
Explanation: Administration received correspondence from our City Attorney in the national opioid suit, Tim Smith from Smith and Johnson and Bernstein Law Group, will update us on the suit.

APPOINTMENTS
BOARD, COMMISSION, AND COMMITTEE REPORTS
GENERAL PUBLIC COMMENT
ANNOUNCEMENTS
ADJOURNMENT

Respectfully Submitted

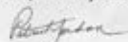
Patrick S. Jordan
City Manager

The meeting was called to order by the Honorable Mayor Mark Ammel at 7:00 p.m. in the Council Chambers of City Hall located at 410 Ludington Street.

Present: Mayor Mark Ammel, Council Members, Ronald J. Beauchamp, Tyler DuBord, Todd Flath, and Karen Moore

Absent: None

Also Present: City Manager Patrick S. Jordan, City Clerk Phil DeMay, Department Heads, media, and members of the public.

City Clerk DeMay led Council in the Pledge of Allegiance.

Moore moved, DuBord seconded, **CARRIED UNANIMOUSLY**, to approve Regular Meeting minutes from November 2, 2021, as submitted.

ADJUSTMENTS TO THE AGENDA

Ammel moved, Moore seconded, **CARRIED UNANIMOUSLY**, to approve to move NB-4 Closed session to the last item of the meeting before adjourning.

DuBord moved, Flath seconded, **CARRIED UNANIMOUSLY**, to approve the City Council Agenda as amended.

CONFLICT OF INTEREST DECLARATION – None

BRIEF PUBLIC COMMENT

Joe Kaplan – discussed the 5-year Recreation Plan and applauded the efforts of all involved.

PUBLIC HEARINGS – None

UNFINISHED BUSINESS – None

NEW BUSINESS

NB-1 Approval and Adoption – Five-Year Recreation Plan – Recreation.

The Recreation Advisory Board held a Public Hearing and approved a resolution on the draft Five-Year Recreation Plan on November 9, 2021. The Recreation Advisory Board recommended City Council to approve and adopt the Five-Year Recreation

Plan. A resolution needed to be passed by the City Council.

“**NB-1** By Council Member Moore, seconded by Council Member DuBord:

RESOLUTION 21-17

**City of Escanaba Resolution of Adoption
For the City of Escanaba Five-Year Recreation Plan
Delta County December 16, 2021**

WHEREAS, the City Council is made up of representatives from the City of Escanaba, and

WHEREAS, the City of Escanaba's Recreation Advisory Board began the process of developing a community recreation and natural resource conservation plan in accordance with the most recent guidelines developed by the Department of Natural Resources and made available to local communities, and

WHEREAS, residents of the City of Escanaba were provided with a well-advertised opportunity during the development of the draft plan to express opinions, ask questions and discuss all aspects of the recreation and natural resource conservation plan, and

WHEREAS, the public was given a well-advertised opportunity and reasonable accommodations to review the final draft plan for a period of at least 30 days, and

WHEREAS, After the 30-day public review and comment period, the City of Escanaba's Recreation Advisory Board reviewed the final draft of the recreation plan and approved the plan for final adoption by the City Council, and

WHEREAS, a public hearing was held on November, 9, 2021, at the Catherine Bonifas Civic Center, 225 North 21st Street, Escanaba, MI by the Recreation Advisory Board to provide an opportunity for all residents of the planning area to express opinions, ask questions and discuss all aspects of the City of Escanaba's Parks and Recreation Plan, and

WHEREAS, after the public hearing, the Escanaba City Council voted to adopt said City of Escanaba Parks and Recreation Plan for 2021 through 2026.

NOW, THEREFORE BE IT RESOLVED the Escanaba City Council hereby adopts the City of Escanaba Parks and Recreation Plan.

Upon a call of the roll, the vote was as follows:

Ayes: Moore, DuBord, Beauchamp, Flath, Mayor Ammel
Nays: None

RESOLUTION DECLARED ADOPTED.”

NB-2 Approval – Lease Amendments between Bay College and the City of Escanaba – Recreation.

Administration sought City Council approval on two lease amendments between Bay de Noc Community College and the City of Escanaba.

NB-2 (a) Moore moved, Beauchamp seconded, to approve first amendment lease between Bay de Noc Community College and the City of Escanaba.

Upon a call of the roll, the vote was as follows:

Ayes: Moore, Beauchamp, DuBord, Flath, Mayor Ammel
Nays: None

MOTION CARRIED.

NB-2 (b) DuBord moved, Moore seconded, to approve second amendment lease between Bay de Noc Community College and the City of Escanaba.

Upon a call of the roll, the vote was as follows:

Ayes: DuBord, Moore, Beauchamp, Flath, Mayor Ammel
Nays: None

MOTION CARRIED.

NB-3 Approval – Contract with CUPPAD – Public Works.

Administration sought City Council approval for a contract with CUPPAD in the amount of \$2,700. CUPPAD will assist the City in developing a site plan and visualization of the inner harbor walkway with integrated fishing piers in Ludington Park.

NB-3 Beauchamp moved, Moore seconded, to approve a contract with CUPPAD in the amount of \$2,700. CUPPAD will assist the City in developing a site plan and visualization of the inner harbor walkway with integrated fishing piers in Ludington Park.

Upon a call of the roll, the vote was as follows:

Ayes: Beauchamp, Moore, DuBord, Flath, Mayor Ammel
Nays: None

MOTION CARRIED.

APPOINTMENT(S) TO CITY BOARDS, COMMISSIONS, AND COMMITTEES

City Manager Jordan, with Council Consensus made the following reappointments:

Glendon Brown reappointed to the Electrical Advisory Committee, term ending January 1, 2025;

Tim Wilson reappointed to the Electrical Advisory Committee, term ending January 1, 2025;

Mayor Ammel, with Council Consensus made the following appointments:

Kelli VanGinhoven appointed to the Downtown Development Authority, term ending April 21, 2024;

Tyler Anthony appointed to the Planning Commission, term ending June 1, 2022.

BOARD, COMMISSION, AND COMMITTEE REPORTS

Council Members reviewed City Board and Commission meetings each attended since the last City Council Meeting.

GENERAL PUBLIC COMMENT

Jamie Strong – discussed sign permits and grandfather consideration.

Laura Coleman – thanked the council for their relationship with Bay de Noc Community College.

Rebekah Anger – discussed zoning and sign ordinances along with grandfather consideration.

Joe Kaplan – discussed his resignation from his board positions. Also discussed bringing back Environmental Advisory Committee.

ANNOUNCEMENTS

- Positions are available for Recreational Advisory Board and Brownfield Redevelopment Authority.
- Board training available for January 11TH
- Standing annual Joint Meeting of Development Boards (City Council, Planning Commission, Zoning Board of Appeals, Historic District Commission, Downtown Development Authority and Brownfield Redevelopment Authority).
- Very successful shop with a cop this year!
- Recreation Department received a grant!

NB-4 Closed Session – Discussion with Bernstein Law Group on Settlement Agreements on Opioid Suit – Administration.

Administration received correspondence from our City Attorney in the national opioid suit, Tim Smith from Smith and Johnson and Bernstein Law Group, updated us on the suit.

The time being 8:11 p.m. DuBord moved, Flath seconded, **CARRIED UNANIMOUSLY**, the Council recessed.

Moore moved, Flath seconded, to go into Closed Session.

Upon a call of the roll, the vote was as follows:

Ayes: Moore, Flath, Beauchamp, DuBord, Mayor Ammel
Nays: None

MOTION CARRIED.

The time was 8:20 p.m.

DuBord moved, Flath seconded, to come back into Open Session.

Upon a call of the roll, the vote was as follows:

Ayes: DuBord, Flath, Moore, Beauchamp, Mayor Ammel
Nays: None

MOTION CARRIED.

The time was 8:36 p.m.

No Council actions were taken during closed session.

NB-4 DuBord moved, Moore seconded, to approve Exhibits A, C, and D at the recommendations of Attorney (Bernstein Law Group and City Attorney).

Hearing no further public comment DuBord moved, Beauchamp seconded, the Council adjourned at 8:38 p.m.

Respectfully submitted



Phil DeMay
City Clerk

Approved:

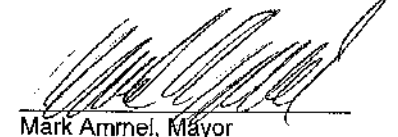
Mark Ammel, Mayor

THIS PAGE INTENTIONALLY LEFT BLANK

Appendix A PUBLIC NOTICE

DAILY PRESS
600 Ludington Street
Escanaba, Michigan 49829
906-789-9122
Federal ID# 38-3365439

I KRISTAL SOPER being an authorized representative of THE DAILY PRESS/ UP ACTION NEWS

Escanaba Michigan, do hereby affirm that NOTICE OF PUBLIC REVIEW -5 YEAR RECREATION PLAN ad(s) for
CITY OF ESCANABA of ESCANABA, MICHIGAN

were inserted first on the following dates:

10/08/21 THE DAILY PRESS
NOT in THE TMC WEEKLY and
NOT on THE DAILY PRESS WEBSITE

that the attached is a true copy thereof.

signature of authorized representative

Subscribed and sworn to before me this EIGHTH day of OCTOBER, 2021

notary public, Delta County, Michigan My commission expires 12-Aug-27

Leslie Lelsner
Notary Public
Delta County
State of Michigan
Comm Exp 8/12/2027

ESCANABA RECREATION PLAN

Appendix A PUBLIC NOTICE

DAILY PRESS
600 Ludington Street
Escanaba, Michigan 49829
906-789-9122
Federal ID# 38-3365439

I JODI BOURDEAU being an authorized representative of THE DAILY PRESS/ UP ACTION NEWS

Escanaba Michigan, do hereby affirm that NOTICE OF PUBLIC HEARING ON FIVE YEAR RECREATION PLAN 2021-2026 ad(s) for
CITY OF ESCANABA of ESCANABA, MICHIGAN

were inserted first on the following dates:

10/20/21 THE DAILY PRESS
NOT in THE TMC WEEKLY and
NOT on THE DAILY PRESS WEBSITE

that the attached is a true copy thereof.

Jodi Bourdeau
signature of authorized representative

Subscribed and sworn to before me this TWENTIETH day of OCTOBER, 2021

Leslie Lelsner
notary public, Delta County, Michigan My commission expires 12-Aug-27

Leslie Lelsner
Notary Public
Delta County
State of Michigan
Comm Exp 8/12/2027

Appendix A PUBLIC NOTICE



NOTICE OF PUBLIC REVIEW

30 DAY PUBLIC REVIEW PERIOD

for the Draft of the City of Escanaba 5yr Recreation Plan

The City of Escanaba Recreation Advisory Board has prepared a draft 5-year Recreation Plan. The plan includes proposed projects such as a splash pad, lakefront pathway and boardwalk, urban forestry plan and lighting inventory. A digital copy of the draft plan is available for review at <https://www.escanaba.org>. Paper copies can be reviewed on site at the Catherine Bonifas Civic Center (225 21st St N), the City Clerk's Office (410 Ludington St.), and the Escanaba Public Library (400 Ludington St.). Please submit your comments by email to jcogger@cuppadd.org or by mail to:

CUPPAD
City of Escanaba Parks and Recreation Plan
2950 College Avenue
Escanaba, MI 49829

Kim Peterson
City of Escanaba Recreation Department
Recreation Director
(906) 786-4141
kpeterson@escanaba.org



CITY OF ESCANABA

REGULAR MEETING OF THE RECREATION ADVISORY BOARD

At the scheduled meeting of the City of Escanaba Recreation Advisory Board on Tuesday, November 9, 2021, at 6:00 p.m. in the Main Meeting Room of the Catherine Bonifas Civic Center, 225 North 21st Street, Escanaba, MI 49829, the following Public Hearing will be conducted:

Public Hearing to hear citizen comment and suggestion on the Five-Year Recreation Plan 2021-2026.

The public is cordially invited to attend this meeting should you have any questions, comments or concerns on the Public Hearing. If you have questions, comments or concerns, but are unable to attend the meeting, please submit your written concerns to the City of Escanaba, Recreation Department, P. O. Box 948, Escanaba, MI 49829, prior to November 9, 2021. All written correspondence will be read into the public record.

Kim Peterson
City of Escanaba Recreation Department Recreation Director
(906) 786-4141
kpeterson@escanaba.org

Appendix A COMMUNITY INPUT + SURVEYS

Escanaba Recreation Survey

Q1 Please select what best describes your residency:

Answered: 422 Skipped: 0

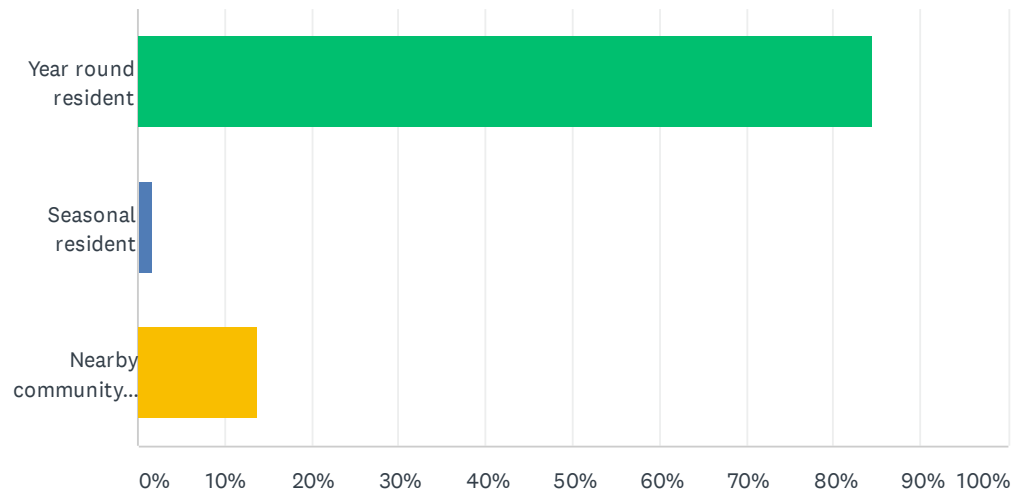

ANSWER CHOICES	RESPONSES	
Year round resident	84.60%	357
Seasonal resident	1.66%	7
Nearby community resident	13.74%	58
TOTAL		422

Escanaba Recreation Survey

Q2 To which gender do you most identify?

Answered: 422 Skipped: 0

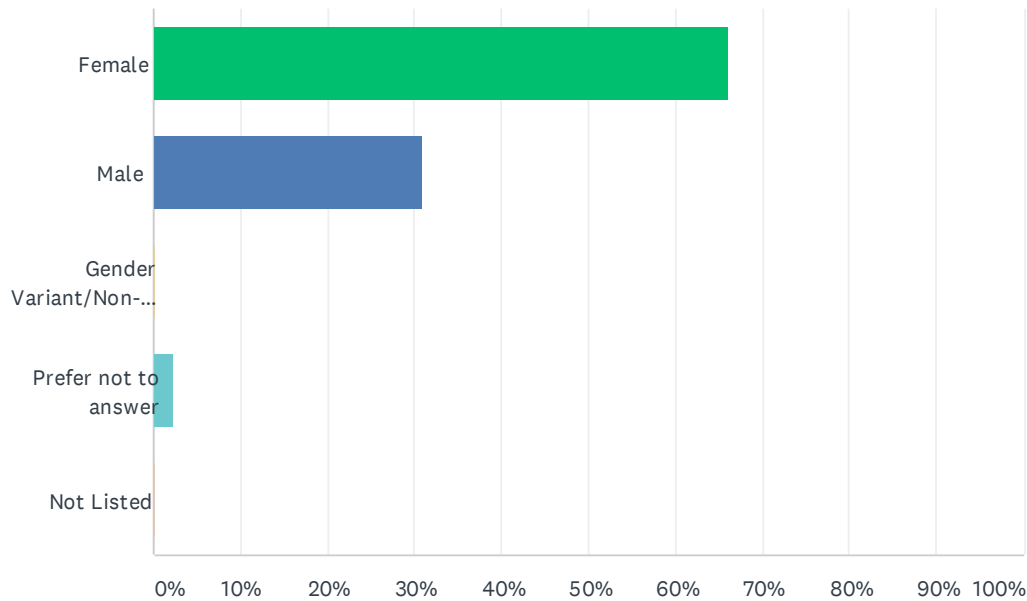

ANSWER CHOICES	RESPONSES	
Female	66.11%	279
Male	31.04%	131
Gender Variant/Non-Conforming	0.24%	1
Prefer not to answer	2.37%	10
Not Listed	0.24%	1
TOTAL		422

Escanaba Recreation Survey

Q3 Are you:

Answered: 419 Skipped: 3

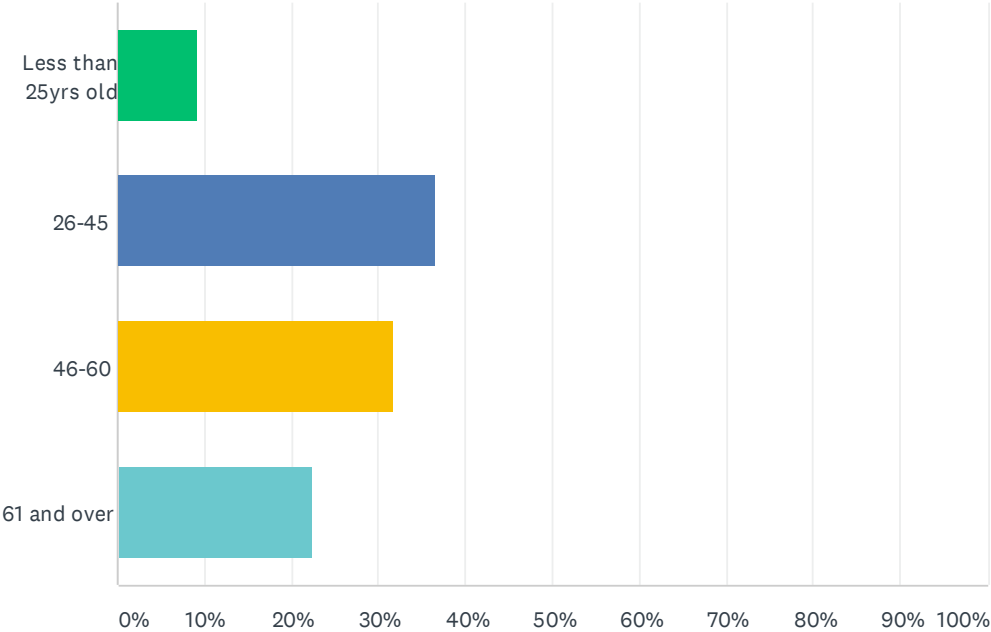

ANSWER CHOICES	RESPONSES	
Less than 25yrs old	9.31%	39
26-45	36.52%	153
46-60	31.74%	133
61 and over	22.43%	94
TOTAL		419

Q4 In the last year, what recreational activities have you or a member of your household participated in? (i.e. playground visits, walking, biking, skiing, sports participation)

Answered: 414 Skipped: 8

#	RESPONSES	DATE
1	playground, beach, walking, driving around	6/4/2021 7:37 AM
2	walking, biking, visiting parks and hiking trails	5/25/2021 8:45 AM
3	walking, visiting the park, beach	5/16/2021 10:41 PM
4	Playground, concerts	5/15/2021 6:10 AM
5	Playground, walking, tennis, basketball, kayaking, beach	5/11/2021 3:53 PM
6	walking, biking, kayaking, snowshoeing,skiing	5/8/2021 9:52 AM
7	Walking, biking, kayaking, camping, snowshoeing, cross-country skiing	5/8/2021 9:41 AM
8	walking; biking	5/7/2021 9:10 PM
9	walking biking sports participation skating	5/7/2021 9:10 AM
10	Playground visits, walking, biking,	5/5/2021 4:46 PM
11	playground visits, walking, biking, baseball	5/5/2021 1:29 PM
12	Hiking, biking, cross country skiing, general nature observation	5/5/2021 7:59 AM
13	Playground. Walking. Biking. Sledding. Swimming.	5/5/2021 6:39 AM
14	Playground, tubing, biking, freebie. Walking	5/4/2021 10:48 PM
15	All	5/4/2021 10:40 PM
16	Walking, biking, kayaking, playground visits	5/4/2021 5:08 PM
17	I walk alot with my dog! We also love biking. The dog park has been amazing but its at the airport.. one by the city park would be really appreciated.	5/4/2021 4:48 PM
18	Walking, hiking, kayaking, paddle boarding	5/4/2021 3:56 PM
19	Playground visits, walking	5/4/2021 2:35 PM
20	Playground visits, walking, swimming at the beach, picnicking at the park	5/4/2021 2:30 PM
21	Boating	5/4/2021 1:50 PM
22	Walking, biking, swimming, tennis, volleyball	5/4/2021 12:04 PM
23	Walking	5/4/2021 10:19 AM
24	SXS/ATV Trail Riding	5/4/2021 10:09 AM
25	walking, biking, live music enjoyment, city band, bike paths, Ludtn Park	5/4/2021 7:03 AM
26	Walks, fishing, swimming and visiting family that live on boats in the marina in the summer.	5/3/2021 10:47 PM
27	Playground visits	5/3/2021 8:30 PM
28	Walking swimming biking	5/3/2021 7:40 PM
29	Walking, playing in backyard,	5/3/2021 4:04 PM
30	SPORTS, WALKING, SKIING	5/3/2021 1:04 PM

31	Walking, Biking, Hiking, Boating, some Playground visits	5/3/2021 10:53 AM
32	Concert	5/3/2021 7:27 AM
33	Playgrounds, especially love besse Park because of the flooring... no woodchips.	5/3/2021 6:49 AM
34	Playground visits, walking, biking, kayaking	5/2/2021 10:32 PM
35	Walking, biking, snowshoeing	5/2/2021 8:42 PM
36	hiking, walking, calisthenics, rock hunting	5/2/2021 8:34 PM
37	Walking, hiking, fishing, biking.	5/2/2021 5:06 PM
38	Play ground beach walking	5/2/2021 3:50 PM
39	walking, biking, hammocking, kayaking, swimming, beach visits	5/2/2021 12:46 PM
40	Tennis, walking, playground etc	5/2/2021 8:12 AM
41	Walking, kayaking, dog park, playground	5/2/2021 7:51 AM
42	Walking biking snowboarding jetskiing fishing	5/2/2021 6:22 AM
43	Walking, biking, swimming	5/2/2021 5:46 AM
44	Walking	5/1/2021 11:24 PM
45	Swimming, kayaking, sunbathing.	5/1/2021 11:22 PM
46	walking, skiing, biking, and kayaking	5/1/2021 10:46 PM
47	Swimming picnicking walking camping kayaking fishing	5/1/2021 10:14 PM
48	playground, beaches, bike paths	5/1/2021 10:09 PM
49	Kayaking, walking, camping, swimming, picnics, boating.	5/1/2021 7:26 PM
50	Walking, biking, cross country skiing, snow shoeing	5/1/2021 5:24 PM
51	Biking, walking, playgrounds,pickle ball,cross country skiing	5/1/2021 3:16 PM
52	Walking, Biking, snowboarding, tubing, playground visits, golf, basketball, football, soccer, rollerblading, kayaking, and swimming.	5/1/2021 1:16 PM
53	Playground visits, walking, biking, snowboarding, swimming, kayaking, canoeing, camping	5/1/2021 1:16 PM
54	Waking or jogging in the park	5/1/2021 12:10 PM
55	aerobics, tennis, pickleball, skiing, walking, biking, boating, kayaking	5/1/2021 10:35 AM
56	Biking	5/1/2021 9:01 AM
57	Walking, biking, skiing, and kayaking.	5/1/2021 8:30 AM
58	Walking	5/1/2021 8:16 AM
59	Biking, tennis, pickle ball, walking	5/1/2021 7:41 AM
60	Playground visits, walking, biking, sledding, skiing, swimming, basketball, kayaking	5/1/2021 5:29 AM
61	walking, biking, boating, sailing, fishing, diving, and polo	5/1/2021 12:40 AM
62	Walking playground beach parks	4/30/2021 9:20 PM
63	Walking, biking, camping, basketball	4/30/2021 6:41 PM
64	playground visit walking	4/30/2021 2:47 PM
65	playground, walking,	4/30/2021 2:44 PM
66	biking	4/30/2021 9:48 AM
67	Swimming, walking, biking	4/30/2021 8:03 AM
68	Walking biking	4/30/2021 7:10 AM

69	Events
70	Walking
71	Playground visits, walking, swimming at the beach, going to the park
72	Hockey
73	Playground, walking, biking, hunting, camping
74	Walking, biking
75	Playground, walking, biking
76	XC skiing, biking, hiking, walking, disc golf,
77	walk, bike, basketball, hammocking, fishing, boating, skiing, swimming, playground visits, ski hill, cross country ski
78	Playground, biking
79	Walking
80	Picnics in the park, boating, fishing, talking grand kids to the playgrounds.
81	Skiing, biking, disc golf
82	Walking, sports
83	Walking, biking, frisbee, throw baseball, fishing, geocaching
84	Walking, Biking, Skating, Longboarding, swimming
85	Walking
86	biking, walking playground visits
87	fishing, playground visits
88	Biking
89	Playground visits
90	Biking, kayaking, fishing, frisbee, walking
91	Yes
92	Walking biking snowshoeing kayaking rollerblading hiking snowboarding
93	Playground walking biking beach park
94	Beach visits, playground visits, walking
95	Walking
96	Playground, walking, biking, swimming
97	swimming, walking, kayaking, fishing, sailing, xxskiing,
98	Walking, biking, picnic, kayak, swimming
99	tennis, pickleball, walking, biking, xc skiing, sailing, snowshoe
100	Boating, kayaking, snowmobiling
101	Walking biking
102	Kayaking fishing hiking
103	Walking, hiking, kayaking
104	Walking, Biking, Disc Golf, Tennis, kayaking, Cross country skiing, ice skating, bonfires, fishing
105	walking

106	Disk golf
107	Playground, sledding, walking, working out, biking, skiing, kayaking, beach,
108	walking
109	Playground for grandchildren, park picnics, playground, concerts, walking,
110	Walking, biking, park visits, beach, etc.
111	All the above
112	none due to covid and restrictions
113	Swimming, biking, walking, playground
114	Playground. Beach.
115	Walking, biking, kayaking, boating,
116	The dog park!! Weekly! Also walking, kayaking, going to the parks, beach
117	walking & biking
118	All of the above
119	Playgrounds, beach, biking, walking
120	Playground visit, biking, walking, swimming, sports participation, camping.
121	Playground visits, bicycling, skiing, golfing, boating, shooting sports
122	Sports programs playground trails
123	Walking
124	biking, walking, hiking, swimming.
125	Boasting, picnic, playground, pavillion
126	Walking, biking, fishing
127	Sailing, hiking
128	Walking.
129	Walking playground
130	Biking
131	biking swimming
132	Walking
133	Walking, biking, and hiking
134	Playground, sailing, swimming, disc golf, hiking, birding
135	Fishing and playground
136	Walking
137	Kyaking, walking
138	Playgrounds ang outdoor music venues
139	Riding, biking, hiking, kayaking, camping, fishing, hunting, boating,
140	Walking, biking, picnicking
141	Walking, biking, skiing, kayaking, playground
142	Playground
143	Hiking, taking in Ludington park, used the new dog park

144	Playgrounds, biking, hiking, snowboarding, kayaking, disc golf
145	Camping/biking/playground/skiing/boating/tubing/beach/sledding/walking
146	None
147	Walking, biking, x-country skiing
148	Playground visits, walking, biking, boating, fishing, running, dog walking, concerts at the park, movies, any type of activity you can think of
149	Walking
150	Running. Walking, picnicking, city band concerts, beach time, kayaking
151	Playground visits, hiking, walking
152	Playground, hiking, casual walks through the park, picnics
153	Walking, beach
154	Parks, fishing, sightseeing around the UP, city band concerts at the park, beach
155	Play ground, walking, biking, fishing, skating,baseball, football, soccer and wrestling
156	Playground, biking, hiking, off road riding on trails (A-G), kayaking, boating, swimming at the beach
157	Walking
158	Playground, walking
159	Mostly walking/running, and the dog park
160	Bike, kayak, snowshoe, run, golf, frisbee golf, basketball, swim
161	Biking, skiing,hiking, walking.
162	Walking, hiking, waterfront art festival, city band, music concerts, parades
163	Playground, walking/running, sports
164	Biking walking sailing
165	Walking
166	Walking, biking, hiking, running, kayaking, fishing, playgrounds, skiing, baseball/softball.
167	Biking, jogging, walking, skiing, hiking
168	Walking, biking, playground visits
169	Walking, kayaking, sailing, biking
170	Biking, skiing, boating
171	Walking at the park. City Band concerts. Music in the park. Sidewalk sales.
172	Walking
173	Walking, hiking, biking.
174	Walking, biking, playing music
175	Walking, golfing, city band, Monday night concert in the park,
176	Biking walking playgrounds hiking site seeing
177	Playgrounds, picnics, walking, biking, Skiing, sledding, swimming, frisbee golf, kite flying, rollerblading, jogging,
178	Walking, fishing, boating,family outing,motorcycling park bbq
179	walking, running, Escanaba City Band concerts
180	Hiking running biking swimming snowboarding skateboarding disc golf

181	Walking hiking and ground visits swimming fishing
182	Biking, fireworks
183	Fishing, tournament fishing, golfing
184	Playground, walking, biking
185	Fishing launches
186	Play ground
187	Walking, concerts in the park and dock area
188	Music in park, movie in bark, playground, swimming, walking, and picnics.
189	Playgrounds,snowmobiling,camping
190	Four wheeling
191	Walking, running, volleyball, basketball, playground, concert
192	Walking,
193	Playground, walking, biking, boating, swimming
194	Playground, beach, gazebo
195	Biking, skiing, walking
196	Playground, skiing, hiking, beach, dog walking
197	Walking, biking, beach
198	Park and beach
199	Hiking, Swimming, Photography
200	playground visits, walking, biking, swimming, horseback riding, bonfires
201	playground visits, walking, biking, skiing, disc golf, ORV
202	Walking, biking, skiing
203	walking, hiking, kayaking, canoeing, cross country skiing, snow shoeing, birding, bicycling, golfing
204	All of the local playgrounds, biking, hiking, walking, boating, fishing (yes, boating & fishing are different).
205	Hiking in Stonington and marquette.
206	Playground visit walking
207	walking, biking, golf, playground visits
208	Soccer, football, cheer, track, football, baseball, playgrounds, beach, nature walks, fishing
209	Playground, walking & fishing occasionally
210	Walking,biking,playground
211	Playground, swimming, walking, sledding, sports, biking
212	Biking, hiking, kayaking, XC Skiing
213	Playground, walking, biking
214	Walking, biking
215	Walking, kayaking
216	Walking biking
217	Playground visits, walking, biking, picnics, swimming



218	Walking, biking
219	Running, skiing, biking, hiking
220	Walking, snowshoeing
221	Playground & walking
222	Ludington. Park
223	Walking, dog park
224	Walking in the park, biking also, love music in the park
225	Playground visit, walking, beach
226	Playground, walking, biking
227	Walking. Biking. Swimming
228	Hiking, biking, walking, beach time,
229	Walking, Biking and Swimming
230	Biking and boating
231	None COVID kept everyone home
232	Walking biking park festivities
233	Walking and biking
234	walking
235	Biking walking playground
236	Walking,camping,Zumba classes
237	Walking, biking, running, hiking on city trails, sledding, swimming, fishing, city baseball, use of playground equipment
238	Tennis, biking, snowboarding
239	Swimming
240	Walking, park visits
241	Playground,walking,music in the parks, festival's
242	hiking, kayaking, rowing
243	playgrounds, library, walking, womans softball, hunting, fishing
244	Playground, Biking, walking, swimming, birthday party, picnic
245	biking, walking, Civic Center, band concerts
246	walking in parks and on trails
247	Visit walking
248	Biking, and sports participation
249	Walks and kyaking
250	Playground, walking, biking,
251	Playground music in park
252	Biking, walking, disc golf, swim, music venues
253	Playground with great grandkids, picnic, concerts family get together.
254	Fishing
255	Playgrounds, walking paths, concerts, Pavillion parties

256	Beach, □
257	Playground, walking, biking, hiking, sports
258	Walking
259	Walking, biking, kayaking,boating,swimming,,fishing.
260	Playgrounds swimming biking walking skiing beach off roading four wheeling
261	Playground visits, lots of beach visits, and the gladstone skate park
262	Walking and biking
263	Walking, biking, paddling
264	Playground, walking
265	Walking, biking, gardening
266	Daily walks, hiking, skiing, biking, kayaking
267	Walking, biking, swimming, playground visit, sledding.
268	Walking, biking. Kyaking
269	Hiking, biking, bird watching and photography
270	Playground
271	Biking, boating, swimming, music in park
272	All music events, celebrations &biking
273	Walking , playground
274	Tennis, basketball, biking, xc skiing
275	Pickleball, volleyball, cross country skiing, snowshoeing, golf
276	Walking, biking, skiing, camping, swimming, boating
277	Biking, sailing, boating, walking the park, Music Mondays, Rock the Dock, playground, tennis courts, Civic Center
278	Besse park, ludington park, royce park
279	Sledding, walking, fishing, biking literally all of it
280	All recreational activities we can do
281	walking, biking, baseball, fishing
282	Walking, fishing, swimming
283	Sports; beach; walking; birding
284	Pickleball, biking,walking, tennis
285	None
286	Fishing
287	Walking, biking, golfing
288	park visits, walking, biking, boating, sports participation, music events
289	walking, bikinh, cross country skiing, snowshoeing
290	Slow pitch softball, basketball, volleyball, tennis, disc golf, golf, playground
291	Lots of playground visit, biking, camping, golf, snowshoeing, sledding, swimming, picnics at the park, movies at the park, tennis at the park, fishing
292	Playground visits, walking, days at the beach



293	Walking
294	Sailing, walking, bike riding, swimming
295	Biking, skiing
296	Biking and fishing
297	Walking
298	Hiking, dog walking, jogging, biking
299	walking, biking, hiking, cross country ski, baseball, basketball, tennis, football, running
300	Camping, walking, biking, music
301	Hiking
302	Walking, Biking
303	Walking in the park and along the shore
304	Walking
305	Playground, biking, skiing, volleyball, soccer, swimming, walking
306	Lud park activities, walking, swimming
307	No
308	Walking,playground visits,
309	Walking
310	Walking
311	Biking, hiking, disc golf, golf, volleyball
312	Playground, music, walking, biking, picnics
313	Playgrounds, harbor, fairgrounds
314	Playgrounds, beach, walking
315	Playground , walking, park events , parades
316	Disc golf hiking
317	Biking, hiking, swimming, kayaking, snowshoeing, sledding, snowboarding, dog friendly activities
318	Playground, walking
319	Playground, biking
320	Visiting parks, fishing, boating
321	Tennis, golf, walking, biking, swimming
322	Biking, Water sports, Golfing, Walking, Highschool Sporting, Music in park. events
323	Playground and beaches, kayaking, canoeing, fishing, walking, hiking, snowshoeing, xcountry skiing, biking
324	Bicycling all of Escanaba, playground visits to Veterans Park playground, Royce park, Marketplace playground, Ludington Park playground, including gazebo, walkways and memorial fountain, aronson island beach including sidewalk and playground, municipal dock benches, fourth of july and new year fireworks, sledding at Ludington park, and the marketplace Farmer's Market.
325	CC Ski; walking; biking; park visit; dog walking in parks
326	Walking, biking, hiking, sledding, playground visits
327	Playground visits, walking

328	Playground visit
329	Sitting to relax.
330	Walking. Biking. Tennis. Kayaking.
331	Biking,Playground,beach,skiing
332	Playground, walking, biking, swimming
333	Many playgrounds/parks, walking paths, beach, hiking trails
334	Walking biking golf kayaking
335	Park visits, foraging local woodlands, fishing local waters
336	Biking,skiing,walking
337	Biking, tennis, nature trails, beaches, walking, skiing, boating
338	Biking,boating, hiking ,running
339	Playground, biking, hockey and figure skating, cross country skiing, baseball, softball, walking lakeshore drive
340	Playground visits, walking trails, disc gold, golf, swimming, camping,
341	Playgrounds, walking, biking.
342	Playgrounds, walking, hiking, swimming, biking, camping
343	Hiking, playground, tennis, music in the park,swimming, sailing
344	Walking, biking, sports participation
345	Walking, Biking, Hiking, Running, skiing, XC-skiing, playground visits, snowboarding, skateboarding,disc-golfing, tennis.
346	Walking,Biking
347	Sports, skiing, hiking, snowshoeing, biking, visiting parks, dog park
348	Walking, biking, playground with kids, music in the park, beach
349	walking, biking and shuffle board
350	Playground, walking
351	Playground
352	Hiked west trail in winter, ice skated in harbor, softball, all the parks, bikes and rollerblade path
353	Walking, sports
354	At most, walking.
355	Walking, playground visits, biking
356	playgrounds, walking, biking, kayaking, camping, hiking
357	Walking and biking
358	Walking, ATV trails
359	walking/running, kayaking, bicycling, beach recreation,
360	Walks, hikes, biking, swimming, camping, golf, disc golf,
361	Kayaking, running, playgrounds, fishing, beach/swimming, disc golf, golf, biking, walks
362	playground visits, Frisbee tossing, walking, biking, rollerblading, long boarding, ,snowshoeing, cross country skiing, sailing, kayaking, canoeing, volleyball, running
363	Biking, walking



364	Walking, dog park
365	Walking, golfing, cheer, uputt
366	None
367	Playground, bike path, walking, tubing, disc golf
368	Playground, walking, biking, ice skating,
369	Playgrounds, walking, sports participation
370	Park, walking, riding dirt bike
371	Nothing with covid
372	All of the above
373	Playground visits, walking, biking, swimming, trail walks
374	Parks, walking, biking, cross country skiing,
375	Playground , wading pool
376	Playgrounds, biking, swimming, tennis, pickleball, skiing, golf
377	biking, sports participation
378	Playground, biking
379	biking, walking, running, and much more
380	Walking, biking, music in the park
381	Playground visits, hockey, football, campgrounds, walking, bike rides, 4th of July activities, music in the park
382	playground visits, walking, biking, kayaking
383	Walking biking tennis
384	Playground visits, beach visits, running, walking, biking, baseball
385	Walking, biking, kayaking, tennis, Pickleball, cross country skiing, snowshoeing, swimming, playgrounds, music in the parks,
386	Walking in the park
387	Walking in park and trails, kayaking, use of beach
388	Playgrounds, biking, walking, etc
389	Walking, going to the beach and taking kids to the playground
390	Playground visiting, biking, walking, snowshoeing,
391	Daily walks
392	Playgrounds, walking, running, biking, sledding
393	Fishing, hunting
394	Walking, parks, beaches, local festivals
395	Walking, biking, skiing, Soccer
396	Hiking
397	Walking, skiing, biking, paddle boarding
398	Hiking, walking, playground, kayaking, swimming
399	Biking, parks, beach, tennis, basketball, and disc golf
400	Playgrounds, baseball fields, walking trails, little league, movie in the park, 4th of July events

401	Playground
402	Playground visits, beach
403	XC skiing, snowshoeing, hiking, kayaking, swimming, park visits
404	Yes
405	Playgrounds, biking, walking, soccer, beach, fishing
406	playground visits, biking, walking, beach
407	Playground, skate park, skiing, biking,
408	Numerous playground visits
409	Playground, walking
410	Biking, cross country skiing, running, swimming, kayaking
411	Walking
412	Playground,walking,biking
413	Walking biking boating
414	Rock the docks, art in the park, visited parks and beaches

Q5 What do you think of when someone mentions recreation in Escanaba?

Answered: 407 Skipped: 15

#	RESPONSES	DATE
1	Scenery, trees, hikes, ect.	6/4/2021 7:37 AM
2	I think of Ludington park and Aronson Island	5/25/2021 8:45 AM
3	Park and beach, organized sports for kids, disc golf, snowshoe loans, pickleball	5/16/2021 10:41 PM
4	Fantastic opportunities for all	5/15/2021 6:10 AM
5	Ludington park	5/11/2021 3:53 PM
6	park, marina, beach, westside trail	5/8/2021 9:52 AM
7	Park, marina, westside trail	5/8/2021 9:41 AM
8	So much potential!	5/7/2021 9:10 PM
9	parks and activities	5/7/2021 9:10 AM
10	Trails, equipments rentals, swimming and other sport opportunities for kids	5/5/2021 4:46 PM
11	Ludington Park, fun activities	5/5/2021 1:29 PM
12	Walking along the lakeshore, bird watching, hiking WSRA trail system, biking existing pathways	5/5/2021 7:59 AM
13	The parks and all they offer.	5/5/2021 6:39 AM
14	I think what recreation...nothing really pops or stands out in my mind	5/4/2021 10:48 PM
15	Lakeside Park and Westside Trails (off Danforth Road)	5/4/2021 5:08 PM
16	The lake is the first thing that comes to mind! Fishing,kayaking, and paddle boarding! I think of the live concerts In the park.	5/4/2021 4:48 PM
17	Our sad of excuse of a park	5/4/2021 3:56 PM
18	Untapped resources	5/4/2021 2:35 PM
19	I think of the many parks we have and the beach.	5/4/2021 2:30 PM
20	Gladstone	5/4/2021 1:50 PM
21	Fun	5/4/2021 12:04 PM
22	I don't know	5/4/2021 10:19 AM
23	Escanaba barely has any recreation. Glad there is finally a trail head in Escanaba for ATV.	5/4/2021 10:09 AM
24	the lakeshore and Ludington Park; and Music Mondays and City Band concerts in the summer	5/4/2021 7:03 AM
25	Boating, swimming, fishing.	5/3/2021 10:47 PM
26	Parks and the marina	5/3/2021 8:30 PM
27	Not much there	5/3/2021 7:40 PM
28	Baseball	5/3/2021 4:04 PM
29	THE BEACH, THE NEW WALKING PATH BEING BUILT	5/3/2021 1:04 PM
30	That we need more walking and biking areas.	5/3/2021 10:53 AM
31	Dead	5/3/2021 7:27 AM



32	Soccer, tennis, beach, our beautiful park area	5/2/2021 10:32 PM
33	Water sports, fishing sailing walking biking	5/2/2021 8:42 PM
34	The has been less events at ludington park than when I was a kid. I think Gladstone provides better	5/2/2021 8:34 PM
35	Pleasant experience	5/2/2021 5:06 PM
36	Not a whole lot to do	5/2/2021 3:50 PM
37	the beach/ water	5/2/2021 12:46 PM
38	Lacking	5/2/2021 8:12 AM
39	Ludington Part, Civic Center, Dog Park	5/2/2021 7:51 AM
40	Not much.	5/2/2021 6:22 AM
41	The lakefront	5/2/2021 5:46 AM
42	Blah	5/1/2021 11:22 PM
43	hiking, fishing, hunting, camping, swimming, golfing, boating/canoeing/kayaking, food and picnics.	5/1/2021 10:46 PM
44	Love our park but wish there were more things to do	5/1/2021 10:14 PM
45	opportunities	5/1/2021 10:09 PM
46	Walking	5/1/2021 7:26 PM
47	Not much. Not many off road bike paths. The park is nice, but doesn't get used that much	5/1/2021 5:24 PM
48	Needs improvement	5/1/2021 3:16 PM
49	Not enough options. I wish we had our own ski hill, big slip and slide event at ludington, more events.	5/1/2021 1:16 PM
50	Parks, beaches, camping, kayaking, fishing	5/1/2021 1:16 PM
51	Outdoor activities	5/1/2021 12:10 PM
52	beautiful ludington park & harbor. unfortunately the tennis courts are unuseable	5/1/2021 10:35 AM
53	A very long, paved bike path along the water and/or through some woods. A serene location for biking that connects Escanaba to Gladstone and beyond.	5/1/2021 9:01 AM
54	Parks and Rec department, city parks, non-recreational trail.	5/1/2021 8:30 AM
55	Not much to do	5/1/2021 8:16 AM
56	There is none, what are they talking about?	5/1/2021 7:41 AM
57	Somewhat limited	5/1/2021 5:29 AM
58	Water and hiking.	5/1/2021 12:40 AM
59	water	4/30/2021 9:20 PM
60	Limited	4/30/2021 6:41 PM
61	There isn't much	4/30/2021 2:47 PM
62	Ludington Park	4/30/2021 2:44 PM
63	kids kingdom, tennis courts aren't much use for older people. at least put out more benches so people can sit and watch others anyway	4/30/2021 9:48 AM
64	Not much, our community needs life brought back to it. More events at the waterfront. Live music, art shows, craft sales, water events	4/30/2021 8:03 AM
65	Bike paths..campgrounds..outdoor music festivals ..	4/30/2021 7:10 AM
66	Beach	4/30/2021 6:59 AM





67	Golf, tennis, live concerts
68	Beautiful place to participate but needs more activity such as food trucks, events things like that
69	Ludington park
70	Ludington park, playground, picnic areas, swimming
71	Enjoy the lake, camping, rivers
72	Ludington park
73	Needs improvement.
74	an abundance of activities - large chunk of monies spent on recreation in Escanaba
75	Small scale with limitations. Old equipment in need of repair, or vandalized equipment
76	Fishing
77	Ludington park, fishing, boating, restaurants,
78	Ludington Park
79	That it needs it
80	Visit parks, walk, bike, fish, geocaching
81	The Ludington park
82	Beach beautiful park
83	It has been significantly improved in the last 4/5 years. New leadership has proved to be a great decision. Good job
84	what recreatiin
85	A skate park, or mountain bike trails.
86	Adequate
87	Ludington park, Aaronson island, Municipal dock
88	Lake front
89	A park or beach
90	Parks and playgrounds
91	Portage point, ludington park
92	Boating, kayaking, fishing
93	The parks
94	limited opportunities
95	Boating, swimming, baseball, biking, picnic
96	Fun! We have great recreation opportunities in our city!
97	Underfunded
98	Boating
99	A few things to do
100	Minimal
101	Ludington Park
102	Ludington park and waterfront
103	Nothing

104	Boring
105	parks, walking and biking trails, tennis, volleyball and basketball courts, performances like city band, rock the dock, Fourth of July activities.
106	Our park and activities to do
107	The park
108	the park
109	Go to the park
110	It severely lacks and I wish I could relocate to somewhere with more things to do.
111	Beach, Kids Kingdom, water activities,
112	The water front, baseball diamonds, walking the parks, the dog park!!
113	our parks
114	Not the park.
115	Needs work
116	Missed opportunities. Aging facilities.
117	A low participation level
118	Opportunity for more
119	Not a lot available from mature adult
120	Ludington park
121	Shoreline activities, boating, biking, trails
122	The beautiful park, Lake Michigan, hiking trails
123	Ludington Park
124	The Escanaba Yacht Harbor races, the city band performances, the music venues in the park, the hockey in the winter (it used to be held down by Aronson Island), (Art in the Park) events in the park, at the fairgrounds, or downtown, the baseball games, the beer fest events, vintage car events, BBQ downtown, car events downtown, fishing events.
125	Ok
126	Drinking
127	concert or activities for the family
128	Not a whole lot at the time, that should be changed.
129	Beach and boating
130	Not many nature trails, great water front park
131	Would love to say fishing and clean parks, but really its meth users and other drug users using the park. Also several delinquent children that sit in the park and intimidate younger children with their language and actions. Park needs a place for teens, away from where the younger children are.
132	Baseball fields
133	Outdoor music
134	Lacking
135	Kids using playground equipment, sail boats, band concerts, joggers, tennis players, baseball leagues, all the team sports the schools have
136	Ludington park and beach, biking downtown
137	Lacking



138	Water
139	Golf, biking
140	Ok. Needs updates/improvements... water plant is a major eye sore and needs to be more accommodating to travelers that come in by boat. Shops and food options would be so much better
141	Team sports
142	We need more.
143	There's not much for teens or young adults to do
144	A fun activity
145	Fishing
146	Not much to do with the kids besides take them to a playground
147	More casual activity for families. As a mom, recreation has taken on a new meaning over the last two years for me. Finding a place to walk, hike, picnic, and enjoy the community is sometimes difficult.
148	Events, parks, yacht harbor
149	Nature, culture, history
150	It's ok but parks are going down hill
151	That there needs to be more things to do. Better notification of events, especially kids sports. Possibly the schools could notify parents of summer sport programs for the kids
152	I will typically look elsewhere. There is a large park area but besides seasonally the beach and fishing there is nothing to draw people into the park
153	Ludington park
154	All of the Parks for children
155	Ludington park
156	Golf
157	Activities!! The parks are great. We need more things to do. Music is universal to all. The city band is an institution we should be proud of that brings people to the park. The art festival is great. The parks, by themselves, mean little if nothing is done to let residents know what is happening within them. What I THINK of? its that this time has one of the most amazing parks, band shells, waterfronts, etc..... yet the city does SO LITTLE to get people to use the parks. Its as if they do MORE to make it harder and more complicated.
158	Beachfront parks, band shell, trails for cross country skiing, atv/other motored things you can drive.
159	Need more trails. More activities
160	Sport team centric.
161	Ludington park
162	Ludington Park
163	Summer sports in the park and lakes. Winter skiing. Art in the Park. Band concerts
164	Sailing
165	Ludington Park
166	Our beautiful park. Music. Players de Noc. The Boniface.
167	The park the beach the marina
168	Parks and festivals

169	Ludington park
170	boating, fishing, band concerts
171	Nothing available to do
172	Lakeshore Drive and the park, bowling
173	Boating,fishing,water-skiing
174	Ludington Park, The Harbor, The boat launch
175	Ludington park
176	it sucks
177	excited
178	How we have squandered the resources and let the Bass and Walleye Tournament organization move all the money and resources to the Sault St Marie and Marinette/Menominee and Oconto area. This has cost us Millions of dollars a year.
179	Water and park activities
180	Ludington Park
181	Sports area play grounds campgrounds
182	The park area
183	Kids soccer, playground, 4th of July, Music in park, swimming, and fishing
184	Laugh
185	Boating
186	No restaurant
187	Fishing, snowmobiling
188	Ludington Park
189	Organized
190	Not much here, if your not a water enthusiast
191	Beach, parks
192	Not enough!
193	Biking, trails, ball games, park and beach activities
194	Lakeshore recreation: walks, swimming, picnic's
195	tennis
196	Lots to do if you get up and look for it!
197	Improvements at WSRA. Need for off highway pathways to Wells Twp.
198	I think of the City Forest, Portage Marsh, Ludington Park, golfing, and walking on sidewalks, and biking.
199	The lack of utilization of the marina.
200	Disc golf which sucks
201	Good things
202	Ludington Park, Civic Center
203	Gatherings at Ludington park
204	Ludington Park
205	Not much available



206	Usually the park area. I'm there often with kids enjoying the festivities and spending family time there
207	Great potential and resources, yet limited commitment
208	The parks are ok. The free snowshoe and ski rental is a nice benefit.
209	Not much to do compared to when I lived in Marquette, that's for sure!
210	Golf, kayaking
211	Hiking biking trails water sports on lake outdoor activities XC skiing
212	Lived there most of my life and know the wonderful summer opportunities offered
213	Ludington Park
214	Up until recently, a wasteland. But since the WSRA has been developed, it's got possibilities.
215	West side trails
216	Kids
217	Biking or walking
218	There's not much geared toward teens
219	Bike paths, swimming in lake Michigan, boating in our beautiful lake, fishing tournaments
220	Sports, park, beach
221	Not much - Esky City Council has minimal, if any, imagination or creativity. For God sake - DO something to maximize the God given assets this community is blessed with!!
222	Minimal
223	I love our park and beach but we need more hiking. I drove to days river often and it would be nice to eliminate that drive. We also need new park restrooms. Some near the kids playground and some near the band shell. I wish there was a section of our park that was wooded. So kids could have a little forest to play in. Similar to veterans park but bigger and more wooded. We need more beach parking and more parking near the boat launch and island point. I like to go to the beach down there and we always have to walk a long way. There's always plenty of open parking at the boat launch but it's not open to the public. We need a splash pad or wading pool near harbor hideout. I love that there are volleyball nets and tennis courts in the main park. Tennis courts in the other parks are great too!
224	We need more options
225	Lake Michigan
226	Ludington park
227	Not much
228	Walking,biking and picnics
229	Ludington Park
230	Luring ton park Ball fields Golf course
231	Ludington Park
232	I feel that we have a strong recreation department with very talented employees, however I feel the overall importance and upkeep of recreational facilities take a back seat to the city's importance and need more attention from leadership within the city.
233	Boring
234	The Park
235	The waterfront
236	Parks,

237	pathways for walking
238	fishing, swimming, camping,picnics
239	Beach, playground, biking,
240	Ludington Park
241	Everything from golfing to disc golf to fishing to swimming, and more!
242	Not much to do, Especially for visitors
243	Not many activities, but a nice area
244	Parks, play grounds, beach
245	I wish I had more time to enjoy
246	Swimming
247	Open recreational use for all ages. Soccer, tennis, older children area. Small childrens areas volleyball, concerts, picnic areas, food carts or trailer for food, water, sodas,atc. Handicap accessible picnic table .
248	Ludington Park
249	Outdoors sporting, family fun
250	The park is so big but under utilized
251	That it needs updating but there is so much potential
252	No comment
253	Water sports beach front activity
254	Ludington park
255	Fishing, biking, playgrounds
256	There's not much to do and our waterfront and downtown are not being properly utilized.
257	Poor leadership
258	Volleyball, walking/running, kayaking
259	Predictable, routine events
260	Walking, hiking, skiing, swimming, boating, fishing
261	Swimming, boating
262	Water
263	Facilities need to be upgraded and modernize. Facilities appear " worn out" in a number of cases. West side hiking trail is the exception.
264	The park
265	Ludington Park
266	All festivities in the park
267	Winter sports like ice fishing , snowmobiling, and fishing, ATVing, beaching, etc
268	Neglect
269	Civic center, tennis courts, beach
270	Unutilized water/park area. It's on the water, no restaurants, very few events. Lost tourism revenue.
271	Ludingfton Park, karis bandshell, sailing
272	ludington park



273	The park
274	It needs to be upgraded
275	The Park
276	Biking, boating, walking, play ground
277	Nothing
278	Escanaba City Park
279	What recreation?
280	We need more and it maintained better. More scheduled events in the park. Concerts, night movies, art shows, festivals, sporting events, etc. Things that draw more people to the park.
281	Beautiful park
282	love it!
283	I think of the civic center
284	Still waiting on the promised slow pitch softball field that was promised when bay was torn down
285	We don't utilize our amazing park and beaches enough. There is so much we could do or update for kids, family's or visitors. We have the ability to use our waters, beaches and parks way more than Marquette does but they have us beat.
286	Days spent enjoying the nice weather at Ludington Park either at the playground, walking throughout the park, or swimming at the beach.
287	Our park is underutilized, not a tourist destination and ugly underdeveloped waterfront.
288	Beautiful
289	Lagging behind other UP communities. Lack of imagination.
290	The park/ harbor area
291	The Ludington park
292	Walking in the park, swimming and boating.
293	Ludington Park
294	Bay beach amusement park that is what Escanaba needs
295	Water
296	What recreation?
297	Concerts in the park
298	Ludington park, DCNTrails, Civic Center, YMCA, boating, swimming
299	Our parks need updating, things look run down and tired. Can't see the fountain with overgrown trees. Lack of anything flowering. Do we need a "friends of the park" fundraising group?
300	Doesn't exist....we have a park where you can go sit for the day...that's it for recreation. We have a ton of banks and auto parts stores though!
301	We have a great start. The biggest beautiful park in a 100 miles radius. We need to expand on that.
302	Our beautiful lakefront park.
303	Ludington Park - walking, beach, playground, music, celebrations
304	We need more trails
305	All sorts of outdoor activities.
306	Not much available...we haven't capitalized on the resources that surround us.

307	Could use some work.
308	Mediocre
309	Older facilities. Upgrades to meet modern demands are needed
310	The main park on Ludington, fishing/ice fishing/boating
311	There is not enough for the kids to do.
312	ATV riding
313	Fishing Boating
314	The beach/waterfront
315	I think of an organization that creates and maintains fun activities for our community.
316	Parks, lakes, rivers
317	The lake and beach!
318	Ludington Park
319	There is room for improvement.
320	Ludington Park
321	Things in the park.
322	Fishing
323	Beach,LudingtonPark
324	The beach and wooden park
325	Nice beachfront well cared for parks
326	Outdoors
327	Multiple opportunities
328	Ludington park
329	Tennis
330	Water sports
331	Besides youth activities like baseball and softball, city of Escanaba does not coordinate much recreation activity. I do think of rock the dock and 4th of July event.
332	Nothing comes to mind
333	The park.
334	Beautiful areas that aren't fully utilized, that are in need of updating
335	Ludington Park
336	Outdoor recreation but with limited opportunities ie number of groomed hiking trails, public beaches, soccer fields, no nature preserve like in Seney.
337	I think that local organizations, like the DCNT are doing a great job, but there are still several opportunities for growth, especially in terms of the waterfront.
338	Outdoor activities
339	Ludington park
340	The park, the beach, disc golf, golf, music events
341	not enough for adults
342	4th of July

343	Lacking
344	Need a community pool, often it is just too windy for the beach. Could be amazing year round for outdoor living
345	Sports fields
346	I guess I don't think about it.
347	Fresh air , socializing, exercise
348	civic center, opportunities
349	Fishing
350	Snowshoes and Ludington Park events
351	outdoor sportsmen (fishing, hunting, riding ATVs or snowmobiles)
352	Ludington Park & Beach
353	Our giant under utilized park.
354	I immediately think of Ludington Park as our greatest recreation asset.
355	A beautiful park under utilized
356	T-ball, soccer, tennis, swimming lessons
357	It is minimal
358	Fishing and boating
359	Ludington Park
360	Outdoors, hunting, fishing
361	We need to make people more aware of what is available in Escanaba.
362	Lack of
363	They need something bigger for kids. There's not much.
364	🤔
365	Need more of it
366	Ludington Park... miss the ice rinks, places to go sledding... beach in summer. Youth sports leagues in summer.
367	Parks and beach
368	We need updates to facilities throughout the city!
369	Civic Center
370	Parks, games
371	Elderly, outdated, old
372	Our beautiful beach and park.
373	Non existent. Not much for kids that the city is actually involved with.
374	more things need to be offered for the young ones, offer more uses for the park, more advertising
375	Walking
376	Ludington park

377	Ludington Park
378	Boating , fishing, biking, enjoying our beautiful Ludington Park, softball
379	The water or the outdoors in general (fishing, hiking, hunting, snow shoeing etc)
380	Ludington Park, not enough for young children.
381	I think we have a nice assortment. I think the beach needs to be cleaned up and loose all that grass/weeds.
382	Playgrounds and biking
383	Ludington park. Beach. Waterfront. The island
384	How little choices there are for doing any recreational activities
385	Ludington park
386	The beach.
387	Fleeting! No more tennis, volleyball tournaments. Skate park gone. Soccer field in disrepair.
388	Outdoor activities
389	Limited
390	Ludington Park: boating, swimming, walking, etc
391	Want more of it
392	The many parks in town.
393	How that it needs to be updated and cleaned up
394	Park
395	History of underdeveloped resources specifically for non-motorized use. (I.e. Walking/hiking trails.) Seems like this is starting to improve though mostly by the efforts and direction of citizen organized efforts. I think the Recreation Department does a good job with the resources they're given but would like to see City Council realize the importance of investing in recreation opportunities to attract not only tourists, but new residents to the community. It's not a gimmick it's something truly Important to many folks especially in my generation.
396	Parks and the beach
397	Exploring, fishing, boating, ATV trails
398	Outside activity. Mainly at the park/beach/band shell/ lake
399	"What recreation in Escanaba?"
400	We need a splash park, a skate park, updated playground at the city park,
401	Recreation seems outdated. The movie nights had been an improvement but timing is difficult for young families.
402	Eh
403	Good xc ski trails snow permitting. Would love to see more fatbiking options in the winter!
404	Beautiful waterfront and Ludington Park. Especially fishing opportunities with two boat launches.
405	Walking,beaches,playgrounds
406	Need more for the kids
407	Water



29	Participation of player's, the many places that are available to use, family orientated activities,
30	WE HAVE AN AMAZING AREA WE LIVE IN AND MAKINGIT EASIER TO ACCESS IS GREAT.
31	That we have a beautiful main park and nice docking areas for boating.
32	That you're trying to improve because their is so much potential.
33	Keeping kids active learning skills and making friends w soccer, playgrounds, beach, basketball
34	The shoreline , the trails for hiking,walking, biking
35	More venues, freedom for vendors and cleanliness. More freedom for occupants
36	The vast opportunities
37	The beach
38	the easy access and location
39	There are some good things
40	Enjoying my limited time off
41	Nothing
42	The waterfront and park, the options available
43	Peaceful
44	The simplicity and beauty.
45	The ability to gather for events, have fun and play
46	It's free!
47	the closeness to everything
48	Lake view
49	The beauty of our area!!
50	Beautiful park
51	The area presents so many options. I value the land that we have, the nature, the bike trails, and the parks that we do have.
52	Clean, safe, fun
53	The scenery. We have a beautiful lake and lots of trees.
54	low cost, or free.
55	The beautiful waterfront.
56	The beach and parks. I would love to see some more unique features to Ludington Park that encourages people to ride down Main Street and support our local businesses.
57	They need more
58	There are none, unless you sail or boat- those facilities are wonderful.
59	Setting - we live in a beautiful place
60	They are clean, fun, and safe. There is variety.
61	water
62	High value of life
63	We have a beautiful lake front that could be utilized more
64	The walking path

COMMUNITY INPUT + SURVEYS

Q6 What do you VALUE about Escanaba's recreation opportunities?

Answered: 395 Skipped: 27

#	RESPONSES	DATE
1	Privacy, and the friendliness of everyone	6/4/2021 7:37 AM
2	The Park Area is great and the walking paths are nice.	5/25/2021 8:45 AM
3	Utilization of our beautiful natural resources. Our park is large and gorgeous.	5/16/2021 10:41 PM
4	Inclusive for all Use of space Variety of things to do	5/15/2021 6:10 AM
5	I love Ludington Park. It is a great place to walk and enjoy the lake shore	5/11/2021 3:53 PM
6	Access, nature,	5/8/2021 9:52 AM
7	Easy access, beauty, doing things with like-minded people, learn new things, nature	5/8/2021 9:41 AM
8	Overall the parks/facilities/recreations areas are well cared for.	5/7/2021 9:10 PM
9	They are seasonal (not just one season)	5/7/2021 9:10 AM
10	Equipment rentals, playground upkeep, beaches, sport opportunities for kids at a reasonable price, sledding, skating	5/5/2021 4:46 PM
11	local	5/5/2021 1:29 PM
12	In addition to existing opportunities, the City and local groups such as Delta County Nonmotorized Trails organization are taking a proactive position to increase access to areas in the City and County at large.	5/5/2021 7:59 AM
13	The variety and convenience.	5/5/2021 6:39 AM
14	The parks for the kids, but hate the wood chips and splinters from the equipment at the Ludington park	5/4/2021 10:48 PM
15	Park	5/4/2021 10:40 PM
16	Free access and the improvement of trails (boardwalks) at Westside.	5/4/2021 5:08 PM
17	HONESTLY, The side walks by the park being so nice to walk on. Nothing is worse then jarring your back on broke up cement or a tree root.	5/4/2021 4:48 PM
18	Community events	5/4/2021 3:56 PM
19	Availability	5/4/2021 2:35 PM
20	I like that there are a number of outdoor things to do. And like the new things they are trying like movies in the park.	5/4/2021 2:30 PM
21	Lots of nice parks not being used everywhere.	5/4/2021 1:50 PM
22	That they are clean and well maintained	5/4/2021 12:04 PM
23	More stuff to do	5/4/2021 10:19 AM
24	We have a great waterfront opportunity here. Could have boat rides, parasailing, dinner cruise, and boardwalks. A good restaurant/bar in the harbor area would also be ideal.	5/4/2021 10:09 AM
25	the beautiful locale, burgeoning music scene in the summer	5/4/2021 7:03 AM
26	That they are plentiful.	5/3/2021 10:47 PM
27	Several parks and a nice marina	5/3/2021 8:30 PM
28	Water	5/3/2021 7:40 PM



65	we like the concerts at the band shell and the 4th in the park. there should be more activities in the park on a daily basis. even food stands with tables during the warm months. it would be nice to have a merry go round in the summer too.
66	Our waterfront and historic downtown area are our most valuable assets. They need an upgrade.
67	Lake michigan...park area
68	Na
69	Ludington Park
70	The beach is beautiful so definitely that, and I guess I'd say the park has been getting nicer
71	Lots of parks, tennis, volleyball, lots of festivals, nice 4th of July
72	Lots to choose from
73	I enjoy when the park is utilized for community events.
74	Convenient access to trails
75	geared toward our young people
76	Easy access
77	Park
78	We could use more, especially for the teenage youth in the community
79	They're free
80	There isn't any
81	Lots of space, both wooded and open space, band shell activities, pavillion,
82	There are a lot of different things to do
83	The waterfront walking trails swimming area. Boat docks .
84	waterfront/parks
85	better than nothi g at all
86	We have places to build these things but it seems the city would rather the youth do drugs than get out side.
87	Not sure
88	This place is so beautiful. Ludington park is so special and magical. I can still remember the metal signs for the "tot lot" my son will remember kids kingdom playground. What will his kids remember about ludington park?
89	The many parks
90	How in tune everything is with nature
91	Cleanliness of the parks and playgrounds
92	The possibilities
93	Need more
94	The home town feel. The kindness of our community when we are participating in local events or just walking around the park.
95	The access to Lake Michigan.
96	Better biking trails
97	easy access
98	Park

99	Outdoor concerts are good
100	Lake Michigan, parks
101	The many options
102	any activity at our beautiful water front. we are blessed to have this stay. to do picnics, CONCERTS, TENNIS, harbor house, just look around and see what we have and people from out of town are impressed
103	Its peaceful
104	We need more
105	walking and skiing trails
106	Low cost n civic Center
107	Escanaba park, cleanliness, safeness,
108	Need more kids things
109	Accessability
110	We have so much water frontage.
111	Water access, big park,
112	Generally well kept, lots of choices
113	That the parks and playgrounds are scattered thru the city. school playgrounds included.
114	The YMCA and the hockey rinks.
115	I value that they're many parks in the area and a beach
116	Open space, waterfront.
117	The amount of space we have available for so many options
118	Being able to take walks
119	water front preservation
120	Ludington Park is huge, well kept, beautiful. Ball fields, football fields exceptional.
121	That the opportunities that are provided are well maintained.
122	Well kept
123	That we have a safe community where people can come and enjoy the outdoors. That we, as a community, support law enforcement. I sincerely hope that this community continues to support them and show any visitor that we value law enforcement.
124	Our water front and parks
125	I appreciate that our town has one of the largest and most beautiful city parks in the state.
126	the chance to see my community enjoy the park
127	The festivities we hold during the summer
128	It's accessible
129	They are inexpensive to enjoy
130	There's plenty of potential in our park. The space is amazing, and location is perfect for ludington park.
131	I value Aronson Island, I love the beech and the green space, I love the marina, sailing
132	Cheap family fun and entertainment
133	Fishing

134	I value the opportunities the kids have to get exercise and have fun. We also like just driving through Ludington Park to enjoy the beauty and to see people and their activities.	165	Great public park and beach
135	The park and water	166	Music and culture
136	Close to water	167	Free events
137	Openness of the parks, access to water for recreational sports and relaxing.	168	most are free and accessible to most everyone
138	Disc golf, bike trails, and the parks	169	Nothing
139	Family/Friends outdoor enjoyment in a beautiful area.	170	The waterways and beach access
140	Nothing	171	the natural beauty - beautiful sunrises and sunsets - and room to spread out
141	Beauty in the surrounding.	172	The city has an infinite amount of space to develop into any recreational opportunity they see fit
142	Being able to be next to the lake and take in the beautiful view	173	nothing. We used to have a lot going on now we have nothing a movie night once a month. An the Escanaba band once a week maybe. There is no play area for handicapped children and our park is a joke
143	It brings the people in the community closer together	174	could be greatly improved
144	Proximity to the water, not just about sports but music too, and the summertime weather.	175	Golf
145	Large space, well maintained	176	That prime real estate on waterfront is preserved
146	Something for all ages	177	Not overused (yet)
147	Lack of big crowds, friendly people, natural wonders	178	Keeps kids busy
148	Need over trail from esky to Gladstone	179	Live music
149	That Escanaba is beautiful to adventure around	180	It's free, beautiful scenery, clean, and there are a ton of things a person can do down there.
150	We have the opportunity to create a beautiful water front good time. Cedarburg WI in their city park will host legitimate live bands and shows in their city park to draw in a crowd. If we took a page from their book it could greatly benefit the community	181	There isn't much
151	Variety of parks throughout the city	182	That's there's at least something to do, but would like to see more atv friendly activities.
152	We have a lot of options for children	183	Plenty of space
153	The park situated on the lake	184	Nice park
154	The lakefront	185	Easy access
155	The ability to walk and exercise in a beautiful place, in the winter, an institution like The City Band should continue with a Winter Season, inside at the art center of the civic center. They are NOT enough (if any!!) recreational activities to bring the community together in the colder months. We live in a cold area. THERE NEEDS TO BE MORE FOCUS ON DEVELOPING INSIDE, RECREATIONAL ACTIVITIES. We live in a city of elderly people. They need safe, healthy things to do inside, to maintain their quality of life, thru the cold months.	186	I'm not aware of any
156	Year round opportunity for fun, many playgrounds are smoke-free, events like listening to the city band or going to a family movie.	187	I don't again unless you are into water recreation
157	Great lakefront Plenty of opportunity to develop more activities around the harbor and clean up brownfield areas	188	They are free & dog friendly
158	Unused lakeshore	189	The park.
159	Ludington park	190	Our park and beach are unmatched. Abundance of ball parks, courts, sledding hill. Ice rink. We've got it all, well maintained
160	On the lake	191	Shoreline beauty and accessibility
161	Family's can do many things outdoors for free. Attend concerts in the park for free. Things for any age .	192	Beautiful parks all over town
162	The bay and parks and trails	193	Again, the improvements at WSRA to make it accessible year round. N. 30th
163	The generosity of the community that allows for endless use of Escanaba's recreation opportunities.	194	I value the City Forest and Portage Marsh immensely. They are beautiful recreation areas that are great in all seasons. Ludington Park is ok as well but there are a lot of people there and obnoxious loud trucks make the recreation experience less fulfilling.
164	The arts and outdoors.	195	The "safety" of the area.
		196	I wish we had more stuff to do
		197	I don't know
		198	Something for all ages
		199	The beautiful waterfront and activities for the kids



200	Not Sure
201	Increasing my health. Valuable time with family and friends
202	That it's open and free. It's a nice place to go that doesn't cost anything
203	Our outdoor resources, forests and waterfront
204	I don't. There is nothing special about them.
205	Not much so far...
206	Mostly love the park, and water activities, and music by the water.
207	Our Ludington park and Lake Music opportunities
208	There is something for everyone to do and most activities are free to the public
209	Water
210	The WSRA is my only recreational activity.
211	West side trails
212	Our lakeshores
213	Ok
214	The beauty of the scenery
215	Our lake
216	Beach and park
217	Minimal offerings - you have a lot of room to grow!
218	Water...
219	Mostly our beach
220	Parks and Playgrounds
221	Openness
222	Our beautiful park
223	Our beautiful park
224	Ludington Park
225	Beautiful outdoors
226	Natural beauty,not overly populated
227	That they are continuing to come up with new and creative community activities and that they make them free to all community members.
228	None
229	Year round access
230	The variety
231	A lot about of free things to do
232	a place easy to find opportunity to go for walk or hike when drive to esky for some other reason
233	our waterfront, resturants, surrounding wooded areas, bowling
234	Free outdoor recreation
235	exercise
236	They are numerous and close to everyone and everything.

237	The parks
238	Very nice parks
239	Healthy activities for all ages
240	Close by and usually free
241	Its on the lake with beautiful views.
242	Our beautiful lake and park. Boating access . Our waterfront and park and beach
243	Summer
244	Free opportunities to socialize
245	It's so nice down there
246	That there so many options
247	Opportunity for kids
248	Access to parks and beaches
249	How nice the park is, that there's several playgrounds and trails to use
250	Clean playgrounds
251	Water
252	Non motorized recreation
253	The lake has endless opportunities. Would like to see more activities. Vendors, music, family activities, such as races, tug-o-war, etc.
254	Outdoor events in Summer
255	Ludington park, west side recreation area
256	I love the beachfront access and the beautiful park that is both safe and accessible.
257	Ludington Park
258	Availability and access to all.
259	The lake
260	Ludington Park
261	Let's us enjoy our beautiful area!
262	Fresh water, opportunity, fresh air and water.
263	Untapped potential
264	I love the civic center. It's one of the best deals around.
265	The waterfront.
266	The variety of events, the harbor, beach and Ludington Park
267	variety of parks
268	I like that the park can be used year round
269	The opportunity is there it just needs some TLC
270	The parks
271	Availability, safety, restroom placement
272	There is never anyone in our park.
273	Change with the times, different sports become popular year to year (volleyball,disc golf,pickleball) and Escanaba has a knack to accommodate those changes...



274	Non	308	Beauty, safety, proximity
275	We need more variety for all ages.	309	I value our beautiful lake shore, forest and community.
276	Great to get out and about	310	Right out my backdoor, free opportunities
277	all of it! the low cost or free use of public spaces is awesome	311	The versatility and openness of the lakeshore and the interesting history of Escanaba are two of Escanaba's biggest and most important assets in my opinion. In my dream world, Escanaba renews the historic downtown and brings back the 1 mile of shopping, and the beach cleaned up to be a more open, beautiful welcoming vacation spot.
278	cross country ski trails, bike trails	312	Lots of different opportunities
279	Its almost perfect	313	I value the variety available.
280	I love that we are getting more water activities at the park and more movies in the park.	314	Waterfront recreation is ample, several playgrounds to play on
281	I think the park/ beach should have restaurant, wineries, festivals, lodging. Our harbor needs to be a destination	315	Things going on in the community.
282	The city employees work hard to keep things in good repair. We do not promote our water assets	316	Beauty of the lake view.
283	Ludington park	317	Access to Lake Michigan. Ludington Park biking path. Stop people feeding the Geese!
284	Variety	318	The beach and wooden park
285	So many activity opportunities throughout the park, watching those gathered as we drive by	319	I have 2 active young boys and we are happy there are so many parks to burn energy
286	That the park is accessible to everyone and doesn't feel like it's just for those who have money like Marquette's lower harbor now feels. Ludington is everyone's park.	320	Huge park with lots of space
287	Lakeshore	321	Open access
288	There's very little	322	Great location of park by waterfront
289	Clean and family friendly	323	Free, nature
290	The lake shore areas	324	Variety
291	The concerts	325	We have beautiful parks that my family takes advantage of, and the beaches in the summer but I feel that there is the opportunity to do more coordinated activities/tourist events in the parks.
292	Natural beauty/location	326	All the beautiful surroundings
293	I like walking in Ludington Park, but there isn't much else if you're not a child.	327	Waterfront!
294	I don't...when tourists ask me what's there to do in Escanaba...honestly...what can you tell them to do? We needed another bank so bad we tore down the family fun park..elmers restaurant is gone for yet another bank. There's nothing to do in Escanaba as far as recreation.	328	Opportunities to get outside , places to bring the kids, beautiful scenery
295	Water... we have some awesome opportunities. We need to sink some money into our water front.	329	Low cost, easy access
296	Everyone can participate - all age groups.	330	Year around recreation
297	Well maintained	331	I value the work that has been put in on our trail networks in the past few years, 906 Adventure Team, and the event opportunities, such as the MISH offerings.
298	Everything is within walking distance	332	Free, clean, easy access
299	The variety we have in our park.	333	How close and accessible they generally are
300	Water and parks	334	biking
301	Some many options for all ages	335	Art in the park
302	Orv trails	336	Bessie park
303	So much potential	337	Space, but the space needs to be developed with cool things outdoor patios in the park would be cool
304	Large park	338	That they continue to grow
305	The cost is low enough for most families	339	After school outlets for Escanaba's children.
306	Playgrounds are year round	340	So many activities to choose from. Grateful for all choices they provide us to keep our mind and body healthy b
307	Nothing the city does a horrible job creating and maintaining waterfront recreational opportunities	341	baseball



342	Unsure	378	The potential that is there...
343	Affordable. Clean.	379	All the beautiful natural areas close to home that allow my family and I to do our favorite outdoor activities without having to travel far.
344	that they're largely free	380	The trails, parks, and disc golf
345	Beach, boat launches, and large park	381	We have so many parks so parents never have to travel far. Makes it easier to walk or bike with small children.
346	That we have them in general	382	The park is HUGE but is under used
347	Escanaba is developing a trail system that will be a wonderful asset, AND Escanaba has a number of parks for such a small community.	383	Beautiful area
348	4 seasons	384	I value the wonderful job that our recreation department does in maintaining our current opportunities - keeping them clean and in good working order. Bravo there, I know it can't be an easy job. I'd like to see more aggressive cultivation and development of additional and more diverse recreational opportunities.
349	They are mostly free and available to all.	385	We have a variety of places to go to play outside.
350	We have a beautiful area	386	The marina and the beach
351	I'm not aware of them	387	We have lots of room so many things can be happening at once
352	Several youth activities & open beach	388	The scenery makes a nice view for being outdoors in Escanaba.
353	The beauty of the lakefront, the fresh air, the wildlife	389	There is always improvements being made even if it's not something my family may be interested in
354	The variety of recreation options available.	390	Large park.
355	The access to natural habitats for outdoor recreation	391	Lakeside views
356	They're simple at best.	392	XC ski trails
357	Place for the family to hang out!!	393	Plenty of parks for kids and enough tennis, volleyball and the civic center for older citizens.
358	Parks and open spaces	394	Cleanliness and upkeep of parks
359	Hard to say... very limited depending on age groups.	395	The effort Kim puts in
360	The beautiful water and beachfront		
361	Aerobic dancing		
362	Variety, improvements		
363	Tons of parks and trail opportunities		
364	Our beautiful woods, parks, beaches, camping, and bike paths.		
365	That they do something. I guess it's better than nothing at all.		
366	clean parks, pavilion at park, sidewalks, fishing docks, swimming, light house, concerts in the park, art in the park		
367	Wish there were more		
368	A chance to live a healthy lifestyle		
369	Waterfront, band shell, great biking - walking paths (sidewalks in the park area . Thanks for keeping them cleared in the winter! Really appreciated being able to walk safely this winter!		
370	Those that exist have structure and offer availability for all levels of income and grouping		
371	I think it's value is high. It needs more resources.		
372	Cleanliness. Safety ease of access		
373	Nothing as I feel there are no opportunities other than playgrounds		
374	Fishing		
375	I value a diverse offering of recreational activities from both indoors to outdoors year round.		
376	The Department is made up of great people with very limited resources.		
377	Not enough		

Q7 What would you like to STAY THE SAME about Escanaba's recreation opportunities?

Answered: 354 Skipped: 68

#	RESPONSES	DATE
1	The beautiful scenery and the outdoors feel.	6/4/2021 7:37 AM
2	The playground and the walking paths along the lake.	5/25/2021 8:45 AM
3	Free access and events (like concerts in the park, Rock the Dock, etc.)	5/16/2021 10:41 PM
4	Use of Ludington Park	5/15/2021 6:10 AM
5	Easy access, good maintenance	5/8/2021 9:52 AM
6	Maintain facilities that we have, assure accessibility.	5/8/2021 9:41 AM
7	Continue good care of parks/facilities/recreation areas. CONTINUE TO MODERNIZE & LOOK TO/PLAN AS BEST AS POSSIBLE FOR FUTURE EXPANSIONS/IMPROVEMENTS!	5/7/2021 9:10 PM
8	Neighborhood and main parks	5/7/2021 9:10 AM
9	local	5/5/2021 1:29 PM
10	I unencumbered access to areas.	5/5/2021 7:59 AM
11	The options and features.	5/5/2021 6:39 AM
12	The paths around the park a nice	5/4/2021 10:48 PM
13	Free access	5/4/2021 5:08 PM
14	Its nice that you guys have been working on trails by comfort suits. It gives me an opportunity to be outside in the woods with out driving 20 30 even 40 minutes to even have access to wooded areas.	5/4/2021 4:48 PM
15	Bike paths	5/4/2021 3:56 PM
16	Protection of resources	5/4/2021 2:35 PM
17	Not sure	5/4/2021 12:04 PM
18	I don't know	5/4/2021 10:19 AM
19	Nothing is good enough to stay the same. Disc Golf at Pioneer Trail park used to be free. Everything in the park was donated,.. and now there is a charge to play??	5/4/2021 10:09 AM
20	Amount of lake scenery and beach/island available to ALL the people; live music throughout summer	5/4/2021 7:03 AM
21	They stay open to everyone.	5/3/2021 10:47 PM
22	Free access to use the parks and beach	5/3/2021 8:30 PM
23	Open areas	5/3/2021 7:40 PM
24	Locations	5/3/2021 4:04 PM
25	CONTINUING TO IMPROVE WHAT WE HAVE	5/3/2021 1:04 PM
26	I believe that the park should remain public space. Both the boat launch in Ludington Park and North Shore should remain. North 30th trail should remain for cross country skiing, snowshoeing, and hiking.	5/3/2021 10:53 AM
27	Concerts. movies	5/3/2021 7:27 AM



28	Soccer at park for small kids, keep the playground, beach, walking path on Aronson Island
29	Continued update of activities
30	The aging play equipment and building's
31	The availability
32	the amount of open area that can be used or anything
33	The parks are all good, but could be better.
34	Keep what we have and add to it.
35	Nothing. Change it all. This town needs a facelift
36	The waterfront
37	Rule enforcement
38	Unsure
39	The events
40	Keeping it free or low cost
41	boat docks
42	Change is great
43	Ludington park is nice so I would hate to see it get smaller. But there needs to be more organized activities there
44	I think always room for improvement
45	Our current options but I would like see the opportunities expand and build on what we already have
46	Rustic look
47	The park. No buildings built over it.
48	ludington park
49	Keep it non-commercialized.
50	Rock the Dock but I would like to see it evolve into a bigger festival will more local businesses offering unique activities. Like art with the Bonifas, cupcakes from the love of cupcakes being sold, yoooper designz build your own sign, watching walleyes choice fly ties, ect.
51	Park
52	Nothing
53	Family oriented
54	Keep good care of the parks. They are an asset.
55	water
56	Free bike rental, fishing, beach
57	walking paths
58	bike path
59	Bandshell area
60	Na
61	Keep having live music opportunities.
62	The beach
63	Keep lots of parks and plenty of green space

64	Water activities, boat access, tennis courts, walking/biking paths
65	I believe it is important to put keep a sting focus on outdoor recreation.
66	Large parks
67	lots of oppourtunities for children, Ludington Park
68	Ludington park is an asset to the city in my opinion. I don't know if I would change it. If I were to change it I may add more pavilions for weddings and such.
69	Them being free for the most part
70	Nothing
71	Bike path, sports areas, harbor, island and path
72	The bike paths by the park
73	Park
74	leadership waterfront concerts & at bandshell are the best
75	playground for kids
76	Not much there isn't much to do here with out getting yelled at or In trouble.
77	The amount of open space.
78	The attention to festivities within Ludington park. It is the SINGLE most magical part of Escanaba.
79	The number of parks available
80	The openness and availability
81	Everything
82	Free to use
83	Beach
84	I don't know that I'd change anything. Maybe just as to the local activities that are or could be available.
85	The park, so easy for anyone to use, even the elderly and handicapped.
86	Free park access
87	continue good maintenance, easy access and variety of activities
88	Park
89	Nothing need more
90	Beach
91	I don't want to lose any options/activities
92	our water front activities
93	We need a kayak launch at the marina
94	Update please
95	I would like to see Ludington park stay about the same and not over developed.
96	Our park!
97	The parks
98	Walking and biking paths
99	Nothing.
100	Beach, concert area, large kids area just expand/improve it



101	The amount of parks available, lots of trails, walking paths, frisbee, etc
102	The upkeep seems to be pretty good but some repairs could be made.
103	Camping at the park.
104	The beach, number of playgrounds, the walking trails on the island,
105	Open space for leisure.
106	Parks and playgrounds
107	more of them. for older generation
108	Maintenance, fees for boat launch.
109	The quality
110	The park
111	Open to the public and if a small entrance fee is required so that anyone can participate.
112	I think the parks are starting to be used by more people for all kinds of use and would like to expand on there use
113	Do not alter the present use of the parks (for example by building condos).
114	the beach cleaned up and building next to the beach used for what it was intended for
115	The things we offer now, but we need more for young people
116	Everything
117	Focus on waterfront
118	Keep the rural feeling. The UP is like nowhere else, and the parks and trails are beautifully maintained.
119	The beech
120	Everything
121	Fishing
122	Maintaining all of pur city park is important.
123	Park and beaches
124	Beautiful well maintained park
125	The waterfront(s)...
126	Disc golf and bike trails
127	Open hours
128	Kids playground
129	Maintaining of the grounds.
130	Nothing
131	The movie nights
132	Summer activities including weekly band concerts
133	Keep things simple
134	Playgrounds, events
135	Costa are reasonable and everything has a local small town flavor
136	No more new parks just fix the ones up we have
137	I'm not sure

138	Keep the park clean, and keep the trees.
139	Variety of parks
140	The bike paths both paved and the old ski hill ones
141	I'm all for growth and change
142	Do not sell off ANY parkland. They MUST stay the same. Take the arts institutions we HAVE, incorporate them more into increased use of the recreation facilities.
143	All of the above-would also like to see something put in place (signage, law, or ordinance) as marijuana is now "legal", so that children aren't exposed to it in public places such as parks, trails. and beaches.
144	Always room to grow expand and try new things. Seems to be Escanaba's problem is they want to stay the same
145	Neighbors: Don't block my view with park activity.
146	Playgrounds
147	Ludington Park!
148	Use the park and waterfront. They are assets to out home town. Encourage more activities in the park like "art in the park", more concerts.
149	Limit powered vehicles.... ATVs, snowmobiles, etc.
150	Nature Parks, tennis courts, boardwalks
151	Community events. Even though that is hard to do now. Hopefully this summer we can have some back. Like Art in the Park.
152	Everything that we now have
153	The arts
154	Music Mondays, City Band concerts, Rock the Dock, Marina Fest, Uptoberfest
155	accessible
156	I would like you to add some
157	Not sure
158	The commitment from the city of Escanaba to keep up Ludington Park - it is the crowned jewel of the city
159	Not much. Time to move forward.
160	nothing
161	All that they offer and more.
162	Keeping all the parks open
163	Opportunities for locals to be the primary beneficiary
164	Times
165	# of live music events, fireworks 2x per year
166	Music in park, movie in park, kids soccer, volleyball/tennis/basketball and courts are great.
167	Bands,parks,carshows,
168	Town get togetheres.
169	No alcohol
170	Fireworks for the 4th
171	All of it

172	Open beach and parks
173	Nothing everything could and should be upgraded
174	???
175	All of the above.
176	free, located throughout the town
177	Pathway through Ludington Park.
178	I think it's important to keep natural and open spaces. Too often I see natural spaces being converted to "park like" spaces. There needs to be a balance of natural habitat for biodiversity so nature can be EXPERIENCED and cultivated space that provides USE of nature. There are significant differences between the two but they can co-exist. The City Forest and Portage Marsh are good examples of space that is mostly natural habitat with walking trails and no motorized vehicles. While Ludington Park provides recreation in a natural setting with more infrastructure, there is a decent balance of natural spaces incorporated into the built environment of the park. I would leave all three of these incredibly important recreation areas as they are.
179	The feeling of being in a safe community.
180	Nothing. Renovate the park. Actually do something with this city
181	Bring back some stuff for kids like family fun park
182	Still offer summer recreation sports for kids
183	Definitely the music in the park at the bandshell or anywhere in park.
184	Bike paths
185	Things are beautiful, maybe some updates but I love everything about the park
186	Access to the waterfront and forest resources
187	Keep the playgrounds the same.
188	I would prefer nicer, updated parks, and maybe biking trails. Perhaps a biking trail similar to the Iron Ore Heritage Trail from Ishpeming to Marquette and so on. It would be a nice paced trail.
189	Not sure?
190	The hiking trails
191	Swimming, boating, picnics in the park, playground - perhaps update a bit. Beautiful waterfront
192	Concerts in the park
193	Nothing.
194	Nothing...should increase recreation on west side trails
195	Any kids activities
196	Festivals in the park
197	All of it
198	Everything
199	Parks
200	Nothing - I can't tell what you offer that creates significant community enthusiasm or participation. . . Just saying!
201	Open for change. Not much to do compared to even other UP towns
202	The number of parks we have in our small city.
203	Not sure

C

204	Ludington park
205	Park festivities
206	Everything
207	Using the park for events
208	Need to keep what we have now and upgrade
209	Ludington Park
210	The availability to all.
211	Nothing
212	Clean beaches
213	Diversity
214	Free and outside activities.
215	parks with ample walking paths
216	Open space for families/kids to play
217	low cost/free
218	Keep the parks as park land and do not sell for development any green spaces at all.
219	The parks
220	The well kept parks
221	Wading pool
222	Free activities
223	Swim area
224	What we have now is fairly good.
225	Fishing
226	Free, community events, music, kid activities
227	Parking
228	No comment
229	Access to the water and playgrounds
230	Trails and swimming
231	Our park
232	Accessibility
233	Rockin the Bay, (more often)
234	Music events at ludington park
235	The beach and harbor
236	Civic Center.
237	Beach
238	Free park and dock events
239	Keep having all the music events and festivities at the park.
240	Aronson Island, Ludington Park
241	Locations and availability



242	Membership rate at the civic center.
243	We need more recreational activities, but I would say the beach.
244	Music Concerts, beach
245	NA
246	That they stay open
247	Restroom placement, benches, the parking is amazing!
248	the water should stay clean; maybe the waste water department shouldn't flush untreated water into the bay?
249	continue to stay consistent changing with the times!
250	Nothing
251	Change everything, change is good. See what other cities do. We need more to do. Park is empty some days. Sad not many enjoy or use it.
252	the low cost, and variety of events
253	All but a nice slow pitch field
254	Keeping the sporting activities going and maybe seeing more
255	Zero. We need improvement by our city
256	Unsure about this question.
257	Ludington park and beach
258	N/A
259	Something to do for so many interests together tho spaces apart
260	That accessibility that I just referenced. Don't build condos for the rich in the park. Keep it a place of the people.
261	Nothing think about adding more things for young adults to do
262	Varied uses of the lake and its shores
263	Concerts and clean beach
264	Open use/availability of ludington park
265	Music nights at the band shell and Rock the Dock!
266	Nothing....
267	Keeping the programs we currently have and expand on them.
268	No building on the lakefront.
269	Easy access
270	Clean beach, basketball courts, picnic areas
271	Tennis courts, volleyball, bands, fishing. Frisbee golf.
272	All the different parks
273	Large spaces. The waterfront park is the jewel of the rec system.
274	Attention to cleanliness and matenance of facilities.
275	Not sure
276	Playgrounds
277	N/A
278	Value

279	Music in the park.
280	Every thing can always be improved
281	I hope it always stays easy to see the lake around the park area. I love the historical society, Aronson island/the beach and the paved paths around Ludington park/Aronson island/water department drive. The marina is beautiful; I don't boat but I enjoy it. I noticed there were more trees planted on Aronson island, and that's great. I love outdoor dining here in town, and I would like it to stay even after COVID-19 concerns have passed; it makes the town more homey and lively, especially as we lose more buildings as time goes on Ludington street. I love that we have a dog park, but I do not drive and it's a long walk from my home so unfortunately I do not use it. I did see people using it when I visited once, so that was nice! The vast number of playgrounds is amazing for those of us to don't drive; it feels like everywhere in town there is one within a short walk, and it's great for the kids. I appreciate the changes the city has made so far to help accommodate those with difficulty getting around.
282	DO NOT CHANGE OR SELL ANY PORTION OF LUDINGTON PARK. This is who we are.
283	Rock the doc
284	The park
285	Festivals in the park
286	I really love Ludington Park
287	Everything
288	The well maintained parks
289	The events planned in the park
290	Continue operation
291	Activities at ludington park.
292	? Unsure
293	Availability
294	Rock the dock and 4th of July events.
295	The park
296	Multiple options, a variety of play equipment for kids of all ages
297	Public access
298	Maintaining Ludington Park as the jewel of Escanaba
299	I would love the development of the trail network to continue, as well as the development of more youth activities.
300	The activities offered
301	nothing
302	4th of july, art in the park.
303	Bessie park
304	I appreciate how clean they are
305	I guess I don't know what would be offered that I would be interested in.
306	Music in parks, playgrounds, swimming pool for youth.
307	?
308	Free events, Music Mondays, Free family movie nights. telescope event was educational. 4th Fireworks!
309	lakeshore access



310	Kid's play area at Ludington Park
311	I would like to ensure that in the future, there is no threat of land being sold for commercial use in Ludington Park. The amount of green space we currently have should NEVER decrease as the community grows, nor for the sake of growth.
312	Clear sidewalks and continuing to update the dog park.
313	Beach
314	Everything!
315	Low costs
316	Nothing.
317	Kids Soccer
318	N/A
319	Availability for all citizens ..
320	Many park options for kids and families . Ludington park and the beach area
321	We need changes.
322	Keep the civic center open
323	Constant variety
324	Keep the number of parks
325	To utilize our park more
326	Music in the park
327	biking, clean sidewalks, fishing opportunities, concerts in the park, art in the park,
328	Nothing
329	Clean beaches, ludington park, baseball and soccer for kids
330	No less activity
331	I'm not sure
332	The look of the park ,island marina ,beach , municipal dock
333	Nothing! Everything needs improvement
334	??!
335	I appreciate having free or very low cost opportunities.
336	Youth Soccer program.
337	Nothing, we need more
338	Park amenities are nice.
339	Keeping the natural areas as natural as possible
340	Cleanliness
341	The number of playgrounds
342	The movie in the park
343	Nice park for kids
344	Continued commitment to maintenance and cleanliness - again, excellent job here. Continued enthusiasm by the City to welcome citizen initiatives like the Delta County Non-Motorized Trails Group. Seems like they are tailor made to be an instrumental partner/leader in the development of new recreation opportunities in our community.

345	I like the movies at Ludington Park. I like the beach and being able to use the beach house. I love the bike path by the park.
346	We can do everything for Free or usually low cost.
347	Nothing really.
348	Looking for public input on what to improve
349	Lakeside views
350	XC ski trails
351	Leave the green spaces in the parks alone.
352	Low to no cost for equipment
353	The outdoor events
354	Live music

Q8 What do you like to CHANGE about Escanaba's recreation opportunities?

Answered: 381 Skipped: 41

#	RESPONSES	DATE
1	Make more of them, the current level of opportunity in Esiky feels really limited and almost suffocating.	6/4/2021 7:37 AM
2	The beach house is nice but it never seems to be open. I also think there should be more hiking/mountain biking trails because all of the cities around us have a lot of them and we only have one.	5/25/2021 8:45 AM
3	Not sure	5/16/2021 10:41 PM
4	Use of Civic Center in the winter	5/15/2021 6:10 AM
5	I would love to have pickleball courts.	5/11/2021 3:53 PM
6	Sludge dumping at westside trail,	5/8/2021 9:52 AM
7	Dumping of treated sewage at westside trail detracts from feeling of being out in nature, can smell it even in seasons when they are not dumping. More snowshoe trails.	5/8/2021 9:41 AM
8	The issue/barrier that's stops me from recreating in Escanaba is being approached in extremely frightening ways by men who are complete strangers to me. This has happened a lot (and I mean A LOT) over about the last 10 years. Over that time: Three different men have pulled their vehicles alongside me when I was walking and asked me if I needed a ride. Another man in a vehicle approached me very slowly from behind, drove past, parked on a side street, drove away, then a short time later circled me a couple of times on a city block. Another man leered at for a long time from his vehicle at Ludington Park, then a short time later circled me in another area of the park. Another man approached me very quickly at Ludington Park when I was getting ready to get into my car after walking and said in a very over familiar way, with very pressured speech, that he could "help" me--he seemed to come out of nowhere and I was left with the strong feeling that he'd been watching me. Another two men, each on a different occasion, approached and spoke to me on the sidewalk in very over familiar ways, one of them saying in an excited way that "we" were "going in the same direction"; the other approached me very quickly from behind with such intensity that I heard his shoes against the sidewalk, and when he reached me he started talking to me about items I was carrying as if he knew me very well. Also, every time (and I mean EVERY TIME) I'm walking or bike riding, at least once, but almost always several times, men leers at me from vehicles or when walking/passing on the sidewalk. Again, all of these men are complete strangers to me. And, to say it in very clear terms, in all of these incidents their behavior/view of me was obviously predator/prey. I've spoken with a local healthcare provider and a local cosmetologist about some of these experiences; one said she's experienced very similar things also over a long time, and both have heard the same from other women. Any one of these experiences is very frightening. Experiencing all of them, over such a long time, with seemingly no end in sight is terrorizing. Because of all these experiences it's become impossible to think enjoyment and stress relief when I think of recreating in Escanaba. Instead, I feel grinding and unrelenting harassment, fear, and terror. These are the kinds of experiences that stay with you. They are the kind of experiences that make you think, will the next time be physical assault or sexual assault or being forced into a vehicle and kidnapped and human trafficked? Will the next time be all of these? When walking or biking, I almost always see women with frightened/stressed expressions that I recognize and understand. I can't help but wonder how many other women have/are experiencing the things that I have/am. So, what I would like to change: Escanaba is a nice community and a prime location for so many types of recreation. As you're planning for the present and for the coming 5 years, please know that some women want to recreate in Escanaba, but don't much, or at all, because of the kind of experiences I've told you of here. Also, at every step in your planning please include robust discussion about real and concrete things that can be done to (at least try to) deter things kinds of incidents--sometimes three or four small steps together can make	5/7/2021 9:10 PM

an important difference (some ideas: positive press releases/news stories/PSA's about the variety of rec. opportunities in Escanaba, that also mention, in so many words, that creeper (or worse) behavior isn't welcome and won't be tolerated; positive press releases/news stories/PSA's from Public Safety that say the same thing but more directly, maybe also stating a designated person/s at Public Safety to report such incidents to; simple reminders/signage at parks/rec. areas that reinforce the message; etc. I hope things can get better. Thanks for listening. I really appreciate it.

9	Bring back outdoor ice rinks. It is very hard for some youth to get to the sports complex. I grew up near the webster rick and we had a ton of people using it nightly. Plus, it was free. We could walk to it, unlike the sports complex.
10	na
11	In regards to WSRA, I would like to see the discontinuation of annual spreading of waste material from the Water plant, which effectively shuts down one of the beautiful scenic sections of the trail system for a prime user time. The permit to dump these materials should not be pursued again. As well, given the increased use of WSRA, since the establishment of a boardwalk system, I feel it is encumbent upon the City to relocate the public safety shooting range.
12	More areas to enjoy by the marina.
13	Updated playgrounds, cleaner bathrooms, vendors during the summer, a water feature for the kids
14	Improved swimming beach area
15	I wish more of them where dog friendly.
16	The people in charge
17	Once Covid restrictions permit, to have more community-wide events, utilizing the entire park. Consider a marathon/triathalon between Escanaba & Gladstone, uniting our communities.
18	I would like more community events, and I would like the parks to be maintained and kept safe. I'd really like to see the farmers market park cleaned up and reopened. I think a kayak launch would be a great addition to the lake and maybe some additions to the beach area, like a splash pad. I also think it's hugely important to consider adding some indoor recreation opportunities for the colder months. There is nowhere to take young children in the winter to let them run and play. An indoor playground, trampoline park or even just a play place in the mall would be a great addition to our community.
19	North Shore is a wasteland of bad businesses. Kobasic is dead. Time to clean up his mess for starts. Work your way north.
20	Cleaner better maintenance more food trucks
21	We need more stuff to do
22	Create more... or advertise more so people know what IS offered. Maybe add a Zip Line.
23	Mark lanes for walking and biking on Ldngton Park bike paths; more bike paths; increase live music opportunities
24	I feel that Escanaba has not listened through the years and has caused young persons to lose interest. And then when youth try to use it they just get called hoodlums because locals don't want to share it or see to many people in the park at one time. Example, hammocks are a eyesore is one I have heard.
25	Less vandalism
26	Lots more to do for families kids
27	Can't think of anything.
28	WE NEED TO SPEND WAY MORE MONEY AND TIME INCREASING ACTIVITIES AVAILABLE TO PEOPLE.
29	In my opinion we need to have a skate park area in Ludington Park, more bike trails throughout, and a large scale disc golf course in the Escanaba area. I feel like certain areas of

Ludington Park could be enhanced with simple things like a few more bike racks, upgraded benches, and maybe some stone chess boards or something like that. I also feel like there should be some seating in the downtown area. It would be great to have an ice rink in Ludington Park in the winter as well.

30	More festivals, weekend long events, allow alcohol.
31	We need a splash pad or community pool!
32	Provide kayak dock or area by parking lot on aronson island , biking trails, coffee and/or ice cream souvenir shop near beach house or centrally located by parking lot Graduation ceremony at bandshell
33	There are people that complain about the wildlife. Last year people wanted the ducks destroyed because of feces. Leave the wildlife alone
34	Nothing
35	more large trees. maybe hammock posts for people who do not have tree friendly straps
36	Make it better
37	Bad question
38	More beach. More child activities. Bigger corporate stores. Dispensaries.
39	More talk about hiking trails (I'd like to know more!), improvement and cleaning in the entire beach, not just the lifeguarded beach zone. There are many zebra mussels and fallen trees.
40	More Bathroom facilities
41	More kayaking areas, More nature trails for biking and hiking.
42	Would love to see a community swimming pool.
43	updates
44	More access to shops and eateries on the lakefront for boaters, kayaking, family picnics without penalty for alcohol and extended curfew for park. More restrooms and make sure they're open and in good working order.
45	More off road bike paths. Many communities have been able to develop bike or running paved trails through woods or natural areas that the community can use.
46	Much safer bike trail systems
47	Expand our options and build on what we already have to offer. More to get people outside and enjoying the area. More tourist attractions. Gladstone is smaller and beating us in the recreational department it is sad
48	Updates, more opportunities
49	Nothing comes to mind.
50	finish a bike trail to Gladstone. upgrade the tennis courts.
51	I would like to see the trash cans in the parks to change and be sturdy and not easy for seagulls to get into. Plans for something unique in Ludington Park, collaboration with DDA to create bike paths downtown, winter festival in the park-encouraging people to be on skis and snowshoes, several fires available, beer, food, unique winter yooper contest like the outhouse races, winter related vendors(stormy Kromer, Iverson's snow shoes, blades bait and tackle sow shacks).
52	Kids splash pad and Bocce Ball courts
53	More of them, utilize the waterfront, develop trails
54	More options for families
55	We need adult coed for people beyond 20. Think about coed volleyball, walking groups, etc.. maybe you can find volunteers to run these activities and post time and date on your page publically so that residents and visitors can easily find.

87	There should be easier and clearer indications about launching kayaks, there should be a opportunity for someone to have special access to the marina to start a Sea Scout program, also a into sailing course for a youth program. And there should be an more defined swimming area.	114	We need more Opportunity four everyone
88	More biking paths	115	Greater emphasis on the marina - more boat slips, marketing our advantages to Great Lakes boaters. Our harbour is underused for the amount of space it offers.
89	Funding to maintain the tennis courts is always a problem. There needs to be a source of annual funding to cover this so courts can be properly maintained. The DCNTrails group is doing a great job. I would hope the improvements of the trails will be continued.	116	nothing
90	Update the equipment and add curb appeal to the locations	117	More activities for our youth
91	Clean up goose shit	118	Would like to see more festivals, concerts and activities
92	Need more	119	Would like more hiking trails, birding spots, and splash pad
93	Trails	120	More youth programs. Bring in more events. Escanaba has lots of potential to bring tourists in, but people need a reason to want to come here, the large spaces in the park mean nothing unless you utilize it. Try the civil war thing again.
94	I would like too have the Ludington Park tennis courts updated. They are probably the worst in surrounding communities. Also adding pickleball would be amazing.	121	Improved bathrooms, improved trees and plants on the island, improved road on the island
95	no change on the waterfront...keep our beautiful water front park as beautiful as it is today happy to see our water fountain will be seen more by the public . Keep on improving what we have now!!!	122	Have more entertainment at ludington park.
96	No clue	123	Nothing
97	There need to be huge updates.	124	More park activities. Used to be many events at the park. Doesn't look like many people use it anymore. Bring back civil war enactment and other educational activities.
98	I would like to see the cross country ski trail more accessible for people with limited abilities. It would be nice to have a flat section of trail that one can get to without going over hills or other obstacles.	125	It would be nice to have the bicycle paths connect.
99	More things to do for families.	126	More art, waterfront shops and eateries
100	Make it so adults and kids can have fun	127	Not enough for young kids or toddlers to do
101	beach access	128	Open up more of the north shore line... it's rather wasted as is.
102	More kid friendly things. Updated playground. Children's water play area.	129	More community involvement with keeping parks clean and safe, and maintaining public areas
103	More up to date things like kayak launch, kids area updated, new bathrooms, food/drink truck nights, dockside bar/restaurant, parasailing	130	Water plant relocated and small business for travelers...fishing supplies, ice cream, t-shirts....sandwiches, coffee, fruit, smoothies, cotton candy etc. campground options on the water
104	More dog park seating and a water pump inside the fence :) Baseball diamonds better maintained?	131	More family oriented activities and opportunities
105	I like the work your doing. Keep it up please. I know Covid-19 put a damper on things. Chin up.	132	I would like to see more walking , biking and x-country trails.
106	Include something for the middle age folks	133	Everything. Give more a variety of things to do across all ages
107	I would love to see the playground equipments fixed and updated. Replace wood chips with something like Besse Park has. Put in a small playground in that big open grass area for small toddlers to play in. A area for the older kids to hang out in like 13-17 really need something to do.	134	The bands that come to rock the doc
108	More events. Update equipment and facilities. Expand beach areas.	135	More awareness of what they are. I don't know what all those parks offer adults. Mostly just a place for kids other than Ludington. Would like to see tennis courts and volleyball areas fixed up - they are really in bad shape - as well as intramural leagues organized for adults. Pickleball is far more popular than disc golf. More ongoing family opportunities to use park like for family reunions. Better control around parks from illegal fireworks. More food festivals and farmers markets that get the area farmers to participate. More awareness where there are places to bike
109	Would love to see more to do at ludicrous park. More activities for kids, more sports programs	136	More Toddler friendly parks similar to Besse which is often overcrowded, toddler area, cleaner beach, more picnic spots as there is a massive bird poop issue. I would also love to see recreational facilities become peanut free. I cannot take my toddler to parks full of kids when their parents are feeding them peanut sandwiches. There are hundreds of peanut allergy sufferers in the area and it is unfortunate that my toddler cannot participate in all recreational activities even though they are outside.
110	So many times the restrooms aren't open, should be more restrooms by the fountain end of the park as well as another pavilion. Restrooms in the pavilion building would be ideal. Boat launch could be bigger, small shelter and/ or fish cleaning station with disposal area for fish guts. Solar lights on the end of the dock?	137	More winter options - outdoor ice rink? Bring more awareness to all the opportunities! There are a lot of parks/options listed below that we have never heard of.
111	Add some kayak rentals	138	Even more arts and music events
112	No opinion	139	Orv trail from esky to Gladstone, keeping up on sports fields, they are getting embarrassing
113	Be open minded to an event that is new to our area. Encourage feedback. Ludington Park and the Municipal Dock are open to everyone and should remain so.	140	That all of the recreation option stay maintained for the public
		141	We need more to do to utilize our large park during the spring-fall.

56	Add more for the kids. Splash pads or pools would be nice		
57	CLEANLINESS OF PARKS AND BEACHES LESS SHRUBS TO PREVENT CREEPS HIDING IN!	142	Update all the parks, some of them are getting to a point that they're dangerous. (Park by High School track for example.) More variety of activities in Ludington Park. This has increased the past few years but it could be increased more. Look at other cities for examples. At the very least, advertise your events more. I rarely hear about them until a few days before and I'm very active on social media.
58	the lack of variety places need more upkeep		
59	The brush and trees along the shore line. The water can hardly be seen thru some of it. An open shoreline as by the yacht area is BEAUTIFUL!	143	More pet friendly spaces. Or more non motorized trail systems. Maybe some play structures for dogs in the existing dog park.
60	they need to take out some of the grass at the beach. the sand area is too small and put more benches with a view of the water	144	More bike opportunities. Paved and wood. Horseshoe pits should be useable.
61	OMG please deal with ducks and their waste along walking paths .. Please dip into our taxes!!!	145	More bike trails developed.
62	Na	146	BAN fireworks in the parks. You have overlooked Escanaba's oldest parks: the triangle parks along Ogden Ave. THESE parks are the overlooked jewels. This is our true, historic neighborhood. Many of the original houses. Near where OUR HISTORY happened. With power, with water. A simple, beautiful place to sit and appreciate the architectural beauty of this town in a small triangle pocket park. A sculpture (well lit) of our founding pioneers (Aronson, Royce, Ogden) planted by local gardeners, sculpture that honors a city founding father (Royce, Ogden, Aronson, Ludington). Its the first park in ESC. It should be a place we can honor the people who built this place and bring LIFE to the east end of town, which is SORELY in need of help. It needs to be a park about WHO WE ARE. This park is not used since it was an ice rink. With the new hotel going in, just down the street, this look of this area is critical to be the core of the redevelopment and first impression of the thousands of visitors, about to see Escanaba for the first time. A redo of this park would make a HUGE impact on the quality of life in the oldest neighborhood in town. In addition: The farmers market is terrible, by allowing "dealers", the farmers are protesting, not attending, and it is destroying the market, other than crafts. And, its clock does not work. How can this city be taken seriously with broken clocks? The OLD farmers market should be handed off to the native american community, for them to develop their OWN market, and have a voice in redeveloping the east end of town, around THEIR OWN culture. We ALL will benefit and it seems to me, the right thing to do to GIVE them a piece of Escanaba, as our name itself IS native american. Its not being used. Lastly: There should be as much MUSIC as possible. This town has a LONG and significant history in the arts. More than any city in the UP. Culturally, we do not have the "wonders of nature" like pictured rocks. This towns culture IS having things to do, in the pretty places that this city manages. CREATING EVENTS is critical, as is celebrating our most sacred institutions, like The Escanaba City Band. We have been and will always be, a place with things to do. Also, there are street lights along lake shore that hang in to the park. These should be turned on, as should the band shell lights, at night, for safety reasons. With modern light, it will be very cheap, and would increase the amount of time we would have to use the parks. All year, for walkers in summer, sledders in winter. They should ALWAYS be on when the street lights are on.
63	Nothing		
64	more venues, food trucks, events, stuff for kids to do another family fun park, or another outdoor recreation center		
65	Bring Royce ice skating rink back		
66	I would like more hiking paths, splash pad for kids, more winter fun, ice skating etc		
67	Add pickle ball courts, SUP rentals n jet ski , kayak.		
68	I would like to see expansion of what is offered. Similar to what DCN has done is highlighting hiking biking trails. Being that we live in an area and climate where activities can be limited I would love to see more trails especially.		
69	Additional paved paths and Nonmotorized trails		
70	Move dog park to an area more easily accessible and family friendly		
71	Need more pavilions maybe in the parks. Ludington park could use another bandshell facing away from the houses for amplified concerts. We also really need more things for the teens in this town to do. There really is nothing right now for the teens.		
72	A better disc golf course		
73	Have things to do		
74	NA		
75	Make more and different opportunities for different things.		
76	Maybe improve the beach area a little more maintenance and the canoe are should be more inviting	147	Cleaner facilities; the bathrooms are disgusting and it is very difficult to take a child in there. I have told my child to pee outside rather than have to worry about little hands touching germly surfaces. Clean cobwebs off of playground equipment yearly. More opportunity to utilize park equipment: maybe starting more club athletics; beach volleyball, disc golf, etc. food trucks more often :)
77	better access		
78	Like I said there isn't much to do with out spending a bunch of money.	148	More mountain biking trails. More hiking trail. Designated road biking routes
79	We need an indoor recreation		
80	I would like to see more weekend activities and events WITHIN ludington park through the summer	149	Add a campground along the waterfront.
81	Upgrade Webster wading pool, get the outdoor ice rink up and running! People have drinks in their yards, the City can put a rink up too.	150	More bike trails, vendors in the park
82	I would like more involvement or even more organized group activities	151	More bike paths, especially one that connects to Gladstone. Force the Delta Disposal and other companies on the lakeshore to sell, and develop the land like Marquette has!
83	Splash pad for kids and slides at the beach	152	Offer something for the teenagers. Sock hops in the park, dances at the tennis courts. Something for them that is safe and guarded.
84	Splash pad for kids, honestly just go read Rhonda Rowbotham's comment from this Facebook post on the CUPPAD page https://www.facebook.com/1419939501561205/posts/3053171251571347/?d=n	153	More music venues
85	I'd like to see more events at the park for all ages. More teen music nights perhaps?	154	More focus on handi-capable recreation opportunities
86	Add more.	155	I'm not sure.
		156	I'm not sure



157	More outdoor events
158	More litter control
159	Add some
160	The park in Escanaba needs to be cleaned and trash issue solved. It also needs to be open at night for star gazing , walking,jogging.
161	The park was not maintained this past year like it has been in prior years. I also consider the Farmers Market a recreation opportunity and it's sad it has not been supported or promoted. Most local farms have quit coming - and there are only crafts and a re-seller of produce (and not local). All activities need far more promotion to get visibility - radio, newspaper, social media accounts, signage, etc.
162	Need a skatepark
163	more activities, more concerts, more food vendors, better play area for kids, a skate park would be great, actually cleaning and open up the beach area instead if it being over run with beach grass, make it handicapped accessible
164	offer more outings, festivities
165	How we have squandered the resources and let the Bass and Walleye Tournament organization move all the money and resources to the Sault St Marie and Marinette/Menominee and Oconto area. This has cost us Millions of dollars a year.
166	Would like to see better access for those who have mobility issues
167	Less fishing tournaments. More recreational kids fishing
168	Play areas for smaller children
169	More events in the park
170	The wooden playground needs a major upgrade and fixing. I really don't like taking my kids there. The beach where the life guards are is all eroded and it's hard to put a chair there to watch my kids.
171	Would like to see snowmobile route through esc from the trail head.also put a campground on the water in the park like gladstone.alot of wasted space in that large beautiful park
172	Make the town atv friendly.
173	Restaurant
174	More walking, biking, running, & skiing trails.
175	Cut the bushes down by the band shell so we can see the stage.
176	More published
177	Make biking a safer thing to do on roads and more opportunities too ride off road
178	More nature trails, resume kayak rentals at beach, dog friendly cabins at Fuller & Pioneer Parks
179	Like to see more, especially for the kids.
180	I have no idea about civic center activity. Just learned about a shooting range?
181	More scenic hiking trails in the woods and near water
182	more waterfront activities/music/festivals
183	Sludge dumping at WSRA. N. 30th.
184	Stop building in Ludington Park. It is an exceptional park that is perfect as it is. It seems more and more of the built environment is added every year, which means more and more maintenance... why can't people just use the park as it is, why does everyone's new ideas about a new built environment have to be accepted? It takes a lot to maintain a park that size so why do we keep adding things to maintain? Identify areas of the park that can be natural (low maintenance) and focus on a solid maintenance plan for the areas that are built.

185	Utilize what is here. Go to Door County. You are missing BIG MONEY here.
186	Everything. I would renovate ludington park and build a 2nd park down the ways a bit for smaller children. Keep ludington park the same. Offer more hiking trails in public places, maybe rustic camping that you have to walk/hike too, a drive in field to watch the stars and sky events.
187	Get the lowlife out
188	I'd like to see more hiking trails. Most of the trails we have are unkept.
189	More opportunities
190	Not Sure , I think you all do a great job already!! Thank you!!
191	Better bike paths through woods by having Them better maintained. Tried using the bike path behind Meijer and had to turn back it was overgrown
192	Maybe add some new equipment, or at least do some repairs to the old stuff. Beach needs cleaned more often
193	Increase commitment from city and county officials to connect, develop and maintain trails across the area
194	Get rid of the eyesores. Clean up the areas. Offer more family friendly opportunities, including something INSIDE in the winter (not all families want to be outside in the winter).
195	Let there be more opportunities for recreation!
196	Add a kayaking launch area and possibly more water recreation rentals. A nice pier for visitors in the park. A winter ice rink in the park might be nice.
197	Need for the development of the waterfront. Restaurants near the park and marina . More condos near the water for those who want to stay in Escanaba. More water activities. Kayak paddle board rentals. Restart sailing lessons
198	Upgrade Harbor Hideout - Install a splash pad for the children. Good site would be near across from the yacht harbor
199	None
200	Eliminate the sludge dumping and police shooting range in the West Side Recreation Area.
201	More opportunities on west side trails
202	More activities utilizing our beautiful lakeshores
203	Nothing
204	Add things for teenagers
205	Bike paths
206	Add pickleball courts
207	More, more, more. Diversity- think outside the box . . .
208	More focus on things that attract tourism. More hiking/walking trails. Take advantage of the beautiful waterfront that we possess
209	I think I answered that above. ;) but more wooded areas. More walking in wooded areas versus on paths. Same with biking. Maybe a little forest play area for kids. Some kind of water play in ludington park for kids. Including teens. Teens and adults would love a splash park too not just little kids. Food vendors near the beach and museum area would be great. Our beach area needs a spruce up.
210	Its not that I would change anything, but adding too would be beneficial for all
211	More opportunities on the lake ground such as small boat rentals and a dedicated snack or ice cream shop
212	Increased bike path

213	More opportunities for all ages		bike lanes.
214	Weather permitting, ice skating at Webster school should be brought back	246	The beach is in need of being cleaned. It can be difficult to walk barefoot because of all the sharp sticks and debris.
215	Make better use of the Municipal Dock		
216	We need to utilize Lurington Park and Municipal Dock... develop these areas	247	Ludington Park is in need of facility upgrades. Bathrooms need to be modernized, a new bathroom is needed across from the Municipal Dock, Tennis Courts need replacement, pickleball courts should be installed in Ludington. New garbage containers are needed in the parks. New picnic tables are needed in the parks, migratory bird enhancements should be marketed to a "birding" community be the, local or visiting. The kiosks on the Municipal Dock need to be modernized and updated. The ship anchor at Public Works should be strategically placed by the lake similar to the same way Navy Pier in Chicago is done. A photo op missed. Veterans Park should be turned into a "Reflecting Garden". Rose Park needs to be updated as does the outdoor basketball courts on the far north side. A "Splash Park" should be installed at the Municipal Dock
217	Loved Bayfest		
218	I would like to see more upkeep and attention paid to city recreation facilities. More money from the city budget put towards it because it's important to maintain and continue for the health of the community.	248	More play ground
219	Everything	249	More/better access to swimming and water activities.
220	Restaurant near the water	250	The point of Aronson Island got messy last year from the wind. Keep it raked and swept up
221	More diversity is always good. More dog parks	251	Always increase camping
222	More outdoor music	252	Tennis court conditions are terrible. Limited biking trails
223	more and longer off-sidewalk pathways for hiking and snowshoeing	253	I'd like to see Escanaba build some more pickleball courts.
224	Cleanliness. Pavillion, playground & restrooms were filthy the last few times I was there. Goose feces everywhere so it was impossible to walk through grass without focusing on where we could step.	254	Need infrastructure by the water. Front. Area is unutilized.
225	do something about geese (and their poop) in Lud. Park, some community must have come up with solution: dogs to chase them away, annual "goose shoot" ?	255	We need small pavillions with 2-3 tables. Throughout Ludington Park. Places where people can gather out of sun or rain. Petoskey has these & are fully used. The park needs another public restroom. Pickle ball court
226	I have no complaints whatsoever. Your department, in cooperation with the city and volunteers, does a wonderful job.	256	bring back the out door ice rinks
227	Better markings on trails for all ORV	257	I don't like the bands that play for live music. It's really not for young people. Also the curfew for the park is silly
228	More events, allow alcohol sales at events in places like Ludington Park or the Municipal Dock	258	Upgrade the recreations. Basketball courts, volleyball courts are ancient, baseball fields are poorly kept up.
229	Larger pool for children	259	More hiking trails, with a wider variety of plants. Maybe a city employee working the grounds to deter people from littering, and other activities.
230	More eating vendors	260	Recreation should be more engaging for all residents - not just what Mr. Blasier and the people who live on Lake Shore want to see. The park belongs to everyone - not just those who live on Lake Shore Drive
231	More bands! More music! More food! More choices!	261	pickleball added, tennis courts are everywhere in the Escanaba area, pickleball is fastest growing sport in America... zero pickleball courts in Escanaba. PICKLEBALL!!! :o)
232	More bathroom facilities. one or two picnic tables with cement access up to them.	262	More opportunities, utilizing the beach, utilizing the parks, events
233	Pickleball	263	Everything. We need activities and more permanent things in the park to attract more people to use the park.
234	INDOOR playground. It's winter 3/4 of the year and young kids have nowhere to play. More festivals. Make NYE a street fair event. More food trucks at the park.	264	Bocci ball
235	Newer picnic areas, update playground	265	I would LOVE to see some pickleball courts, many people play but there aren't any courts, I know of one in Escanaba, it is the fastest growing sport in America. More bike trails would be nice
236	More upkeep	266	Need a slow pitch softball field
237	Tiny town with a railroad track. Put little buildings in the center for kids to play in. Make replicas of businesses and have them pay to build it! Charge for train rides.	267	Getting people out doing more, biking, swimming, frisbee golf anything to get people out of the house and enjoying what we have to offer
238	Finding away to keep geese away	268	More reason to draw people to waterfront Marquette, Traverse City are booming
239	Better advertisement about location. They're hard to find sometimes	269	Unsure
240	Would like to see a skate park brought to Escanaba and maybe more water activities...i.e. more kayak, paddle board rentals. A bike and scooter pump track. More mountain bike trails.		
241	Add more things to attract boaters and bring people in to the park and downtown.		
242	Maintenance of existing opportunities, creation of new or underutilized opportunities		
243	More music and vendors		
244	Frequency, accessibility for individuals who are handicapped		
245	Getting the waste disposal and police shooting area out of west side recreation area. Better		



270	A dedicated bike trail system that links to Gladstone's. Needs to be well marked, with access to Bay College area. Just look to what Marquette has done.
271	Petition to STOP killing the vegetation in the harbor, it is destroying the wildlife for for perch
272	Gathering area for seniors, maybe benches gathered together for groups to knit n visit.
273	I'd like to see our city government become more of a helper than the current hindrance it is to those who want to bring new ideas and innovation to the city. We can't fear change or cater to a vocal or rich minority who like the status quo. Take a look at how the city lost the civil war reenactors. A very cool event that many looked forward to seeing was lost because a small amount of people didn't like it.
274	Add more accessible walking/bike paths. Better signage and advertising of hiking trails.
275	More music opportunities
276	More things for the teenagers to do
277	More bike paths. More family activities. More senior activities
278	Boardwalk along shore. Maybe a long pier with sitting area at end for enjoying sunsets, fishing ect.
279	Add a skating rink.
280	Updated volleyball posts/nets, cleaner sand for volleyball, wind reduction (via trees/fence/net) near volleyball, connect bike paths to Gladstone paths
281	I would like to see a splash pad. People would drive to Esky to utilize it. It offers an experience that is different than the beach and can be a community gathering place for all ages, if not to get wet, but also to watch.
282	Crest recreation opportunities instead of more damn banks and auto parts stores! This town shoots itself in the foot more than any other!
283	Expand on our current programs and consider using the lake front in different ways.
284	More events
285	Better upkeep and maintenance
286	Can't think of anything at the moment.
287	Harbor needs life (playground, fire pits, restaurants, something for kids). Members pay a lot of money for a slip and not much else. More trails for waking around the community. More kid friendly places for entertainment.
288	Get a park just for babies/toddlers. Slides are too big for littler kids
289	Maybe some vendors other than for special events
290	More things to utilize our beautiful park. City tournaments, fun activities for kids for occasions, more live music
291	More activities. Better disc golf courses.
292	Many playgrounds are outdated/inaccessible and the beach is small and often very full during the summer, even when other local beaches/parks (Gladstone) offer more in terms of fun and activity for young people. Also, much of the focus on recreation is for "sportsman" activities like hunting/fishing/boating. I'd like to see a new emphasis on recreation opportunities for people who don't fall into those categories, like families and young people who want to get outdoors but don't want to participate in those type of activities.
293	More youth programs, upgrade the park, use the park more, maybe a BMX course, obstacle course, work on the beach area, some water activities.
294	Update some of the playgrounds. Painting yearly to look nicer. Keeping grass cut and garbage cleaning
295	City or county residents needing to pay to use boat launches when they are not maintained or upgraded. Especially the launch on Amson Island. The launch and fishing pier is in terrible

	condition.
296	More opportunity
297	Create more opportunities to showcase our beautiful lake shore. More focus needs to be on that. Follow what Marquette is doing.
298	Our beach front should be better maintained, more accessible waterfront activities. More emphasis on hiking and biking paths
299	I would love to see streetlights down the Ludington park road. I'd love to walk/bike the paths at night or before dawn in the winters (I know it's closed at night, but I'm just passing through). I would love to see the beach shore cleaned up of the broken fence and beach grass so the swimming beaches are more visible from the road, and it's less painful to trek to the shore barefoot, and the sidewalk heading east elevated out of the water or at least opened up again to accommodate wheelchairs/three-wheeled bicycles again, who can't pass through now that there are boards on the ground. And if it's not already there, I'd love to see a plaque with the story of how Aronson island came to be. I love sharing it with my friends who are from out of town. It's very cool! I'd love to see Escanaba become more a tourist destination. It's very photogenic and the weather mild, and I see Marijuana dispensaries are using the legalization to encourage people to visit the UP from out of state. Let's give them a reason to stick around, they clearly have the money to burn :)
300	More bike paths!
301	I would like to see a bike path with better signage, and I would LOVE to see the bike path connect to Gladstone!
302	Cleanliness of playgrounds needs to be increased, more opportunities for toddlers and younger children.
303	Discontinue the city band
304	Add more events to capitalize on the area's beautiful ludington park
305	Nothing just need to maintain what we have
306	The geese poop
307	It would be nice to have an indoor playground for winter months
308	A splash pad for kids, updated tennis courts, a long bike path throughout the city
309	Expand opportunities like bike and walking trails
310	Increase biking trails
311	Improve tennis courts, post ski grade schedule for ludington park, outlaw drinking in ludington park
312	Wheelchair accessibility
313	More winter outdoor activity, we missed the outdoor rink this winter. More events for families to attend.
314	Add some for for kids of all ages to do, splash pad for one would be nice
315	More bike paths. Improvements at the beach. More picnic tables.
316	Better maintenance of the parks. They often look shabby- in need of lawn care
317	More diversity, more team sport options for adults
318	More diversity in what's available
319	More water-based opportunities and waterfront development and cleaner playgrounds, as well as more biking lane and walking access throughout the area.
320	Better advertising, updates to dog park
321	Adding a larger variety of recreation opportunities
322	more bike trails that are safe to use

323	More events	350	They seem to be trying to offer new and more activities for families
324	Allow Snowmobile and ATV's access to restaurants and gas stations in town	351	More opportunities for kids. Upgraded park, we NEED a NICE city run outdoor ice rink.
325	Bring back ice rinks all of them even the triangle. Help teach kids how to utilize nature	352	more opportunities for the young, ice skating rink in the park, skateboard park, hold a flea market, summer festival, winter festival, snowshoeing event in the park, area regional rec. dept. coalition, better advertising of events, make better use of the beach house to a year round facility..a 4 season facility
326	Needs more diversity	353	More hiking paths in the woods
327	Nothing that I can think of.	354	More hiking/biking/running trails.
328	More youth activities Maybe a splash park	355	We need to have a community wide weekend to spruce up, make safety improvements at Harbor Hideout! This is a Priority! Expand bike paths! Build more restrooms and have them open ALL YEAR LONG!!!! Maybe have the bathrooms at the tennis court, the bath house and the marina open all year. Put in diaper changing stations in restrooms, especially by the tennis courts and better lighting! Add a restroom at Bessie Park. Have more than one food truck down in the park all summer. More variety! Have more festivals, concerts... look at Marquette for guidance! Tie in with the Convention bureau to add events when large groups come to the area.
329	?	356	Which there were more events down at the park to attend.
330	More events down the main stretch of Ludington Street. More business needs to feel it's worth investing in the older buildings downtown. It shouldn't just be an opportunity to drink. That pushes families away from the events.	357	More opportunities and advertising
331	utilize Ludington Park more, develop an/or enhance more bike/walking/running paths on city property; introduce outdoor dining at more locations	358	Clean up and make the beach bigger
332	I would LOVE to see a splash pad at Ludington, on the north end. Not at Webster, but at the park where most people are during summer months. Splash pad should not require lifeguards, just routing maintenance? Also, if possible slightly more parking on far end of Aronson Island for beach goers.	359	Clean up the garbage , change the amount of garbage pick up for the park ,island, beach , marina . More signage out on the hiway to direct folks to the waterfront . Use social media more to spread the word !
333	Our "bike paths" are not very safe. 5th avenue is horrible. We need to utilize our park more. A splash pad would be amazing! Bathrooms at at least both ends of the park that are well lit and clean. More accessible places to put kayaks in and to be able to park.	360	Everything. Accessibility, options, cleanliness, functionality
334	Our parks need some updating, which I believe is currently in process, but our roads are discouraging to those who wish to reach rec areas via non-motorized transport. I firmly believe we need to create a skate park for bikes, skates and skateboards.	361	Plant more fish.
335	More utilization of the parks	362	I would want to see more opportunities for walking, hiking, biking, etc.
336	Add pickleball	363	Cycle through all activities for maintenance. Scheduled fixes not band aids.
337	For as much lakefront that we border, we need more beach access. We also need more walking trails. More recreation geared towards older children.	364	More of them
338	More waterfront activities, festivals, youth camps, in city limits parks, bring back several ice rink locations	365	More bike trails that aren't on the road.....connect heart of Esky to Gladstone. Better beach maintenance and longer beach house season. More parking and access to the beach from that parking. Better maintenance of tennis/basketball courts
339	Unsure	366	I'd like to see a better solution for the garbage problem, especially in Ludington Park. There really needs to be better garbage can solutions as animals can too easily get into them as well as people being disrespectful. Also better maintenance on the facilities in the park, many are in disrepair.
340	I wish there were more	367	Updates to the escanaba disc course or a new one.
341	More for everyone to do.	368	I would like parks to be more maintained. Surfaces need to be taken care of at tennis and basketball courts.
342	Not sure	369	Fixing up the stuff at the playground in the park. Missing chains, loose chains stuff falling apart
343	Open the ice rinks, heat the wading pool, public pool or splash pad, more youth activities (toddler- school age) such as nature school, make a cross country ski trail around the park and have special event days where people can try out equipment.	370	Splash pad, upgrades to park and beach area
344	Maybe some type of senior activities utilizing the bike path, or walking club ... badminton for seniors.	371	More development. More imagination, engagement and enthusiasm from City Council on promoting development of the resources we have. A good example is the waterfront. I've heard first hand from folks like Patrick Jordan and Marc Tall that "the Municipal Dock will never be allowed to be developed." Yet I've never understood why. They didn't give the impression that it was against their vision but rather that they perceived there would be a negative outpouring of public/private interests toward the matter. Has this conversation actually been invited in recent times?
345	A splash pad for kids in the summer . Something for young kids and families to do in the winter - maybe an inside play area	372	Get rid of the city band. Ugh! I can't believe my tax dollars pay them to play. I would like to see a Christmas light display similar to what Rapid River did last year. Green Bay also does a
346	Add picks all courts, update tennis courts, make a splash pad for young kids or fix the Webster wading pool. We need things that parent with young children can take their kids to safely.		
347	Better bike paths		
348	Nothing		
349	Bike/walking trails connecting city, state, county parks		

Escanaba Recreation Survey

	nice job of their lighted walk.	
373	I wish we had more events at the park all summer/fall long.	4/15/2021 9:57 AM
374	More opportunities for children and adults, alike.	4/15/2021 9:57 AM
375	More things for little kids and teens	4/15/2021 9:52 AM
376	Updated play area, updated beach, more to do in the park.	4/15/2021 9:50 AM
377	New, safer playground. Better beach upkeep.	4/15/2021 9:48 AM
378	Improved fatbike/mountain bike options, expanding bike/walk/run pathways	4/15/2021 9:47 AM
379	Updating of playground equipment and lots of maintenance for facilities.	4/15/2021 9:46 AM
380	More for kids! A splash pad for summer would be excellent, upgrade Harbor Hideout, the farmers market park needs monitoring from ruthless teens destroying it, beach areas could use cleaning out of overgrowth	4/15/2021 9:44 AM
381	Music more often	4/15/2021 9:38 AM

Q9 In the past year, how often have you or a member of your household visited the city owned facilities listed below?

Answered: 422 Skipped: 0

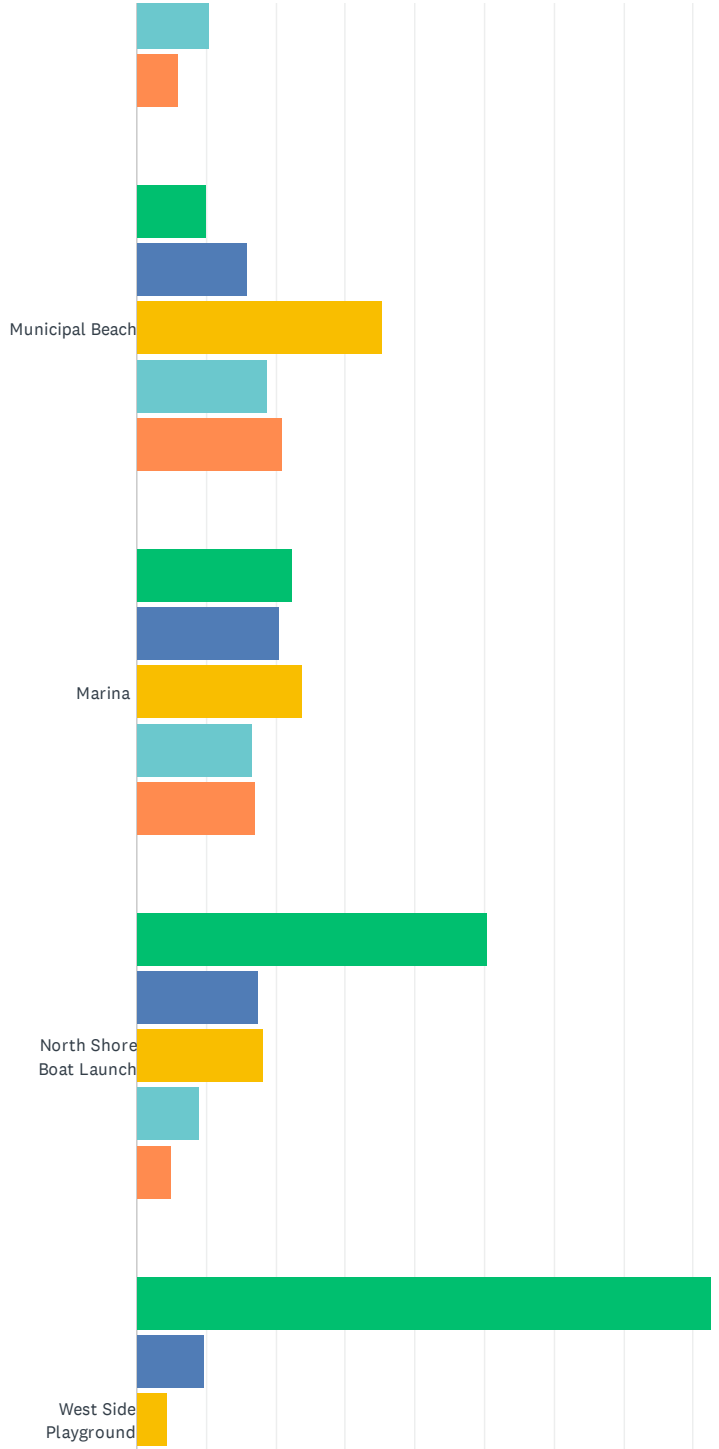
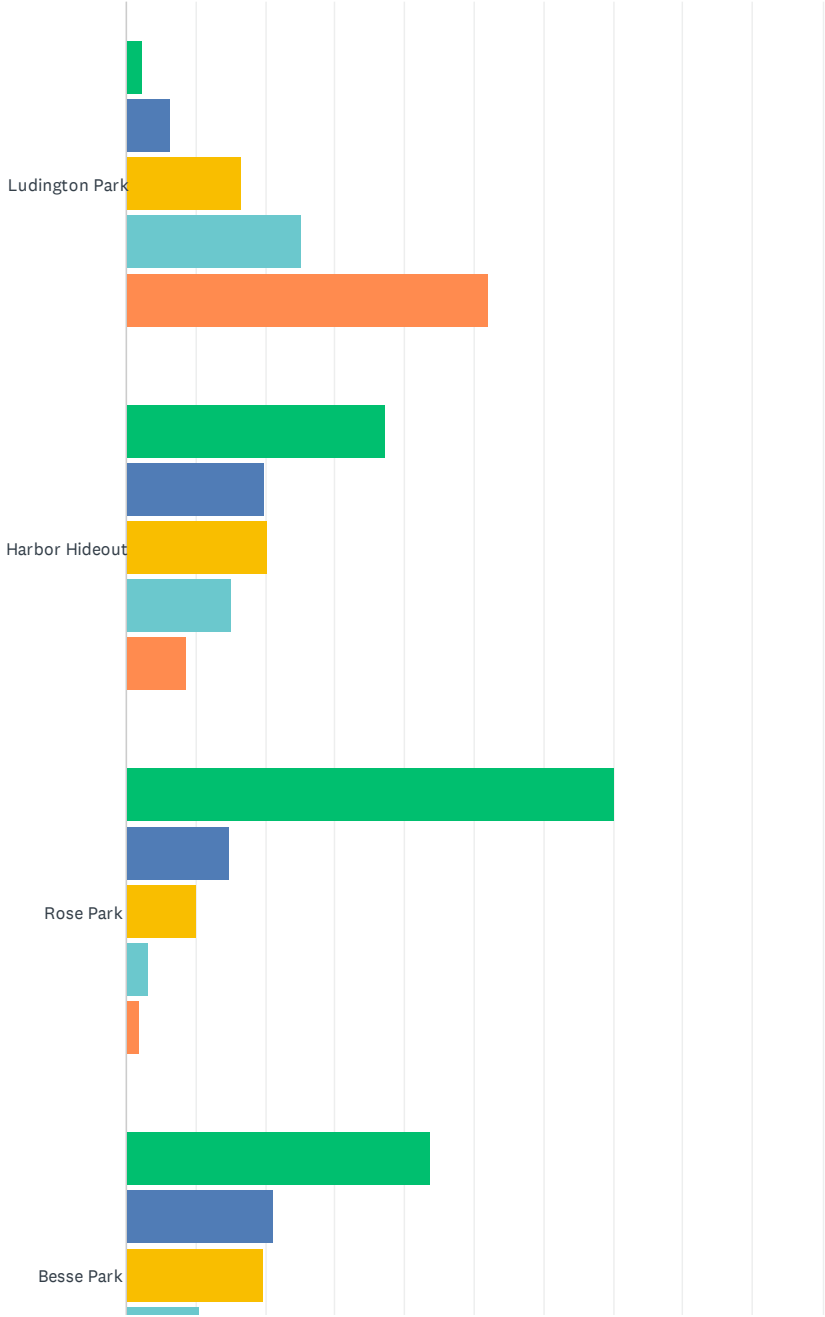

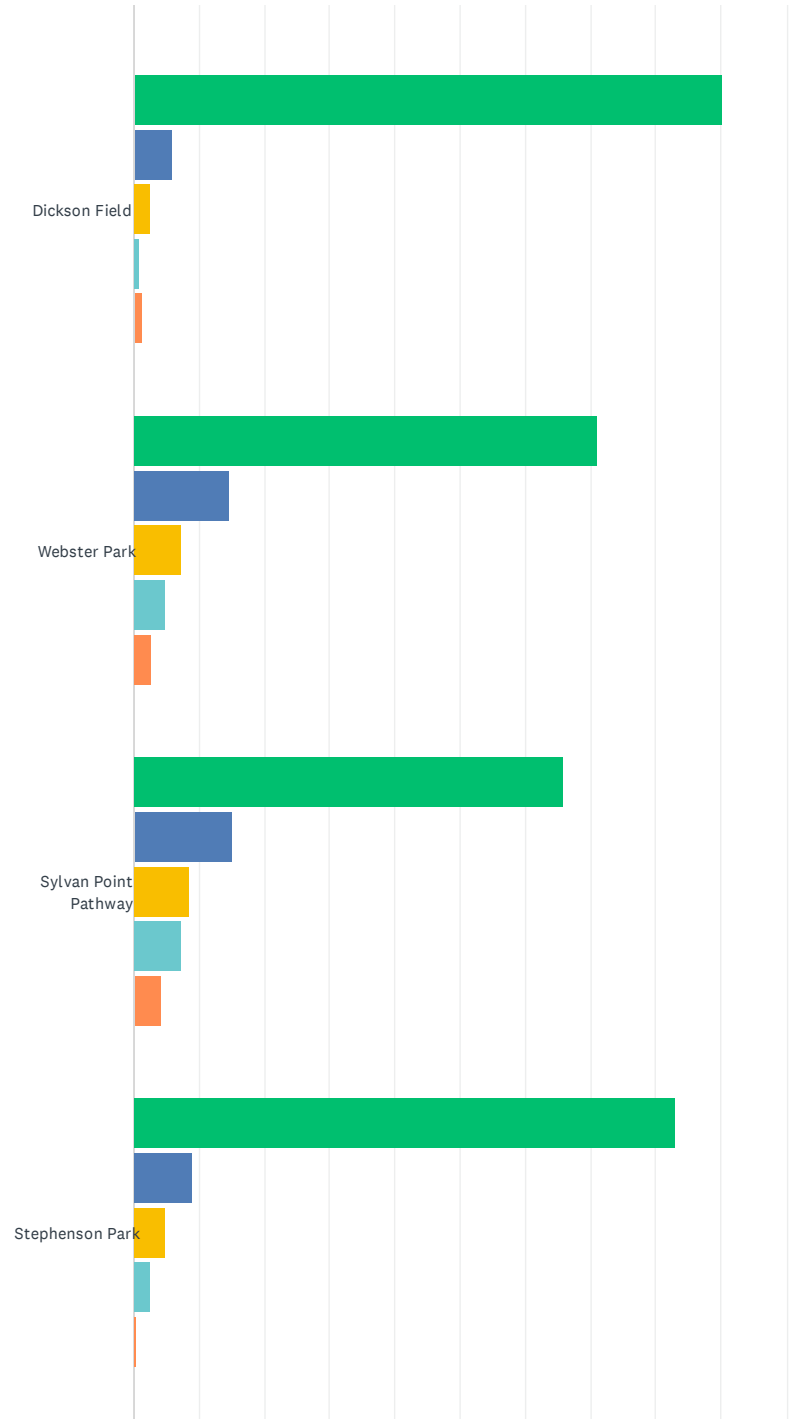
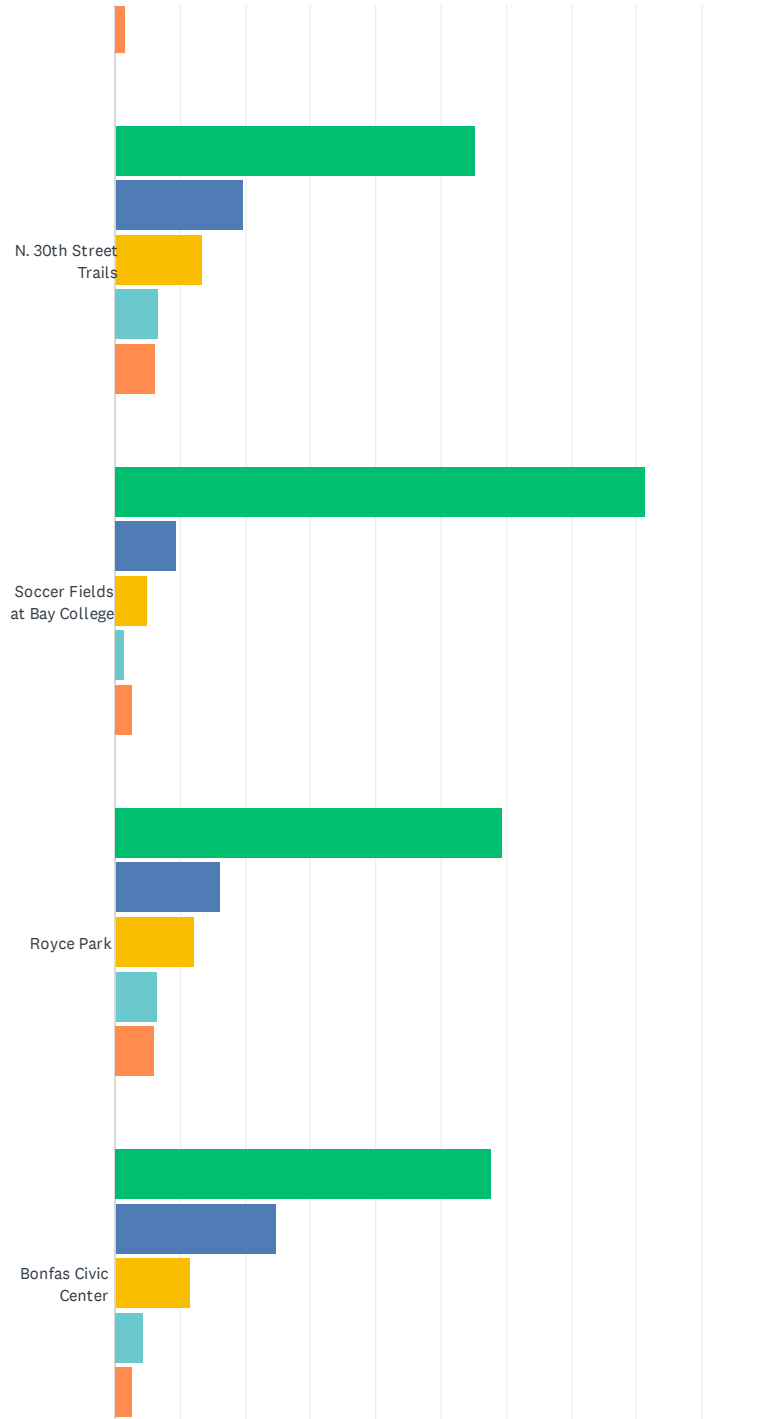

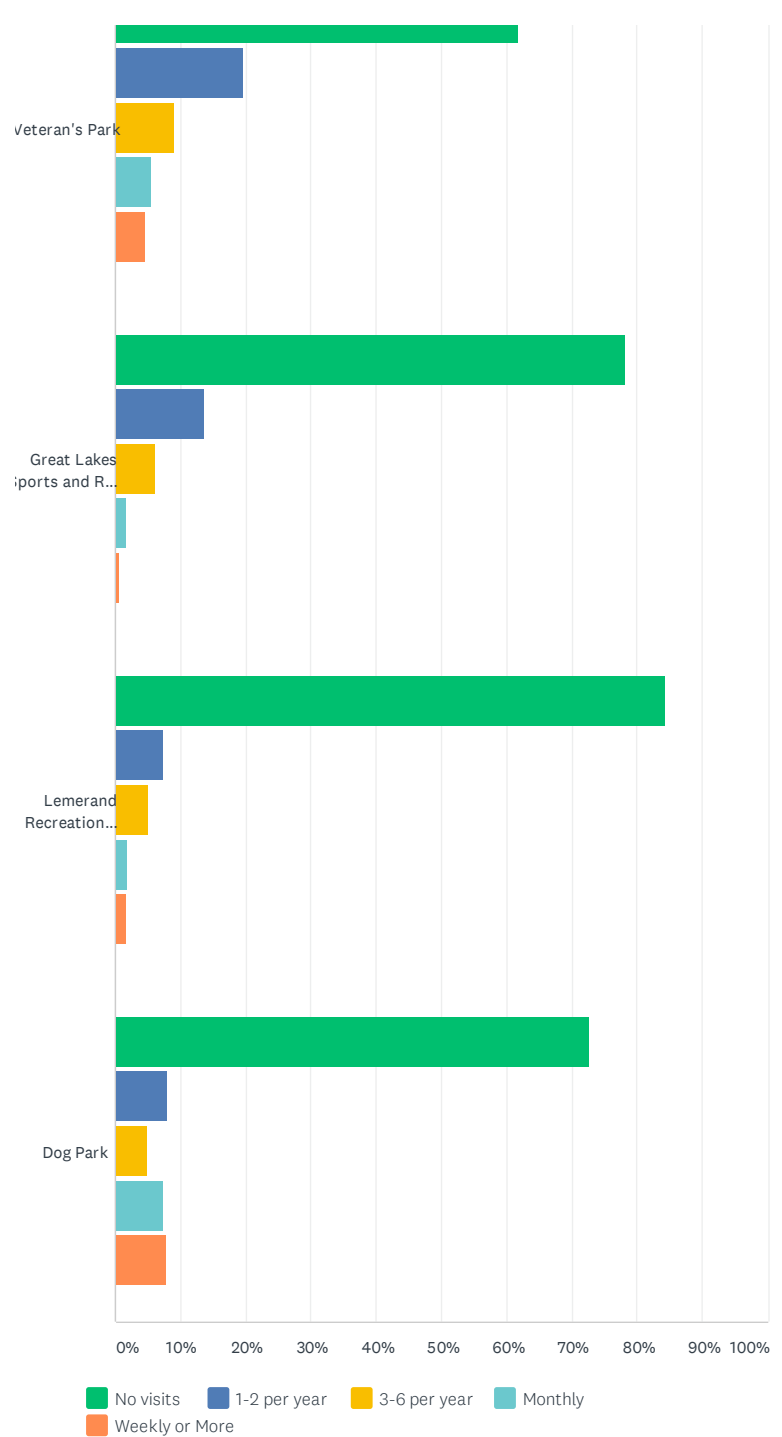
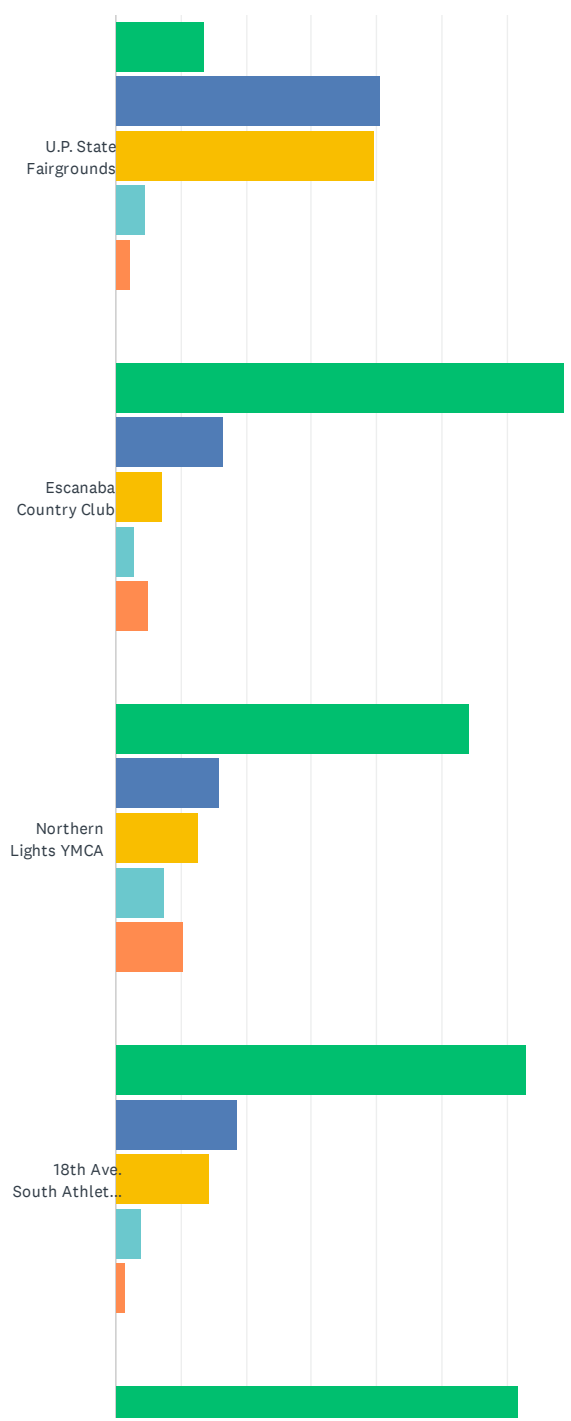

■ No visits
 ■ 1-2 per year
 ■ 3-6 per year
 ■ Monthly
 ■ Weekly or More

	NO VISITS	1-2 PER YEAR	3-6 PER YEAR	MONTHLY	WEEKLY OR MORE	TOTAL RESPONDENTS
Ludington Park	2.38% 10	6.18% 26	16.63% 70	25.18% 106	52.02% 219	421
Harbor Hideout	37.29% 154	19.85% 82	20.34% 84	15.01% 62	8.47% 35	413
Rose Park	70.17% 287	14.91% 61	10.02% 41	3.18% 13	1.96% 8	409
Besse Park	43.66% 179	21.22% 87	19.76% 81	10.49% 43	6.10% 25	410
Municipal Beach	10.02% 42	15.99% 67	35.32% 148	18.85% 79	21.00% 88	419
Marina	22.46% 93	20.53% 85	23.91% 99	16.67% 69	17.15% 71	414
North Shore Boat Launch	50.36% 208	17.68% 73	18.16% 75	8.96% 37	5.08% 21	413
West Side Playground	82.67% 334	9.90% 40	4.46% 18	1.49% 6	1.73% 7	404
N. 30th Street Trails	55.21% 228	19.61% 81	13.32% 55	6.78% 28	6.30% 26	413
Soccer Fields at Bay College	81.31% 335	9.47% 39	5.10% 21	1.46% 6	2.67% 11	412
Royce Park	59.51% 244	16.10% 66	12.20% 50	6.59% 27	6.10% 25	410
Bonfas Civic Center	57.73% 239	24.64% 102	11.59% 48	4.35% 18	2.66% 11	414
Dickson Field	90.20% 368	5.88% 24	2.45% 10	0.74% 3	1.23% 5	408
Webster Park	71.12% 293	14.56% 60	7.28% 30	4.85% 20	2.67% 11	412
Sylvan Point Pathway	65.94% 271	15.09% 62	8.52% 35	7.30% 30	4.14% 17	411
Stephenson Park	83.05% 338	9.09% 37	4.91% 20	2.46% 10	0.49% 2	407
U.P. State Fairgrounds	13.64% 57	40.67% 170	39.71% 166	4.55% 19	2.39% 10	418
Escanaba Country Club	68.86% 283	16.55% 68	7.06% 29	2.92% 12	5.11% 21	411
Northern Lights YMCA	54.15% 222	15.85% 65	12.68% 52	7.56% 31	10.49% 43	410
18th Ave. South Athletic Field	62.95% 260	18.64% 77	14.53% 60	3.87% 16	1.45% 6	413
Veteran's Park	61.67% 251	19.66% 80	9.09% 37	5.41% 22	4.67% 19	407
Great Lakes Sports and Rec Club	78.21% 323	13.56% 56	6.05% 25	1.69% 7	0.73% 3	413
Lemerand Recreation Complex	84.39% 346	7.32% 30	5.12% 21	1.95% 8	1.71% 7	410

	NO VISITS	1-2 PER YEAR	3-6 PER YEAR	MONTHLY	WEEKLY OR MORE	TOTAL RESPONDENTS
Dog Park	72.57% 299	8.01% 33	4.85% 20	7.28% 30	7.77% 32	412

Q10 What should be a priority when addressing the City of Escanaba's Recreation Plan? (1: Highest priority, 2: Moderate Priority, 3: Lowest Priority)

Answered: 419 Skipped: 3

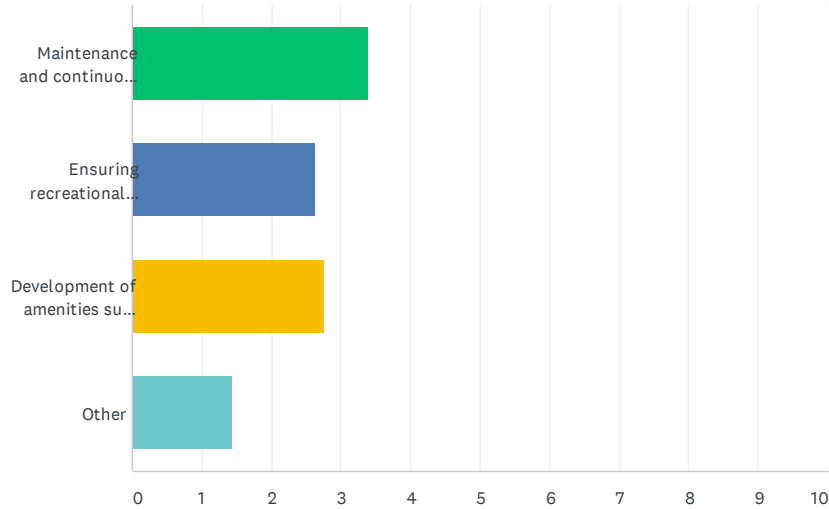

	1	2	3	4	TOTAL	SCORE
Maintenance and continuous improvement of facilities and parks	57.03% 215	25.99% 98	14.59% 55	2.39% 9	377	3.38
Ensuring recreational facilities are accessible to all residents	20.10% 77	32.38% 124	38.90% 149	8.62% 33	383	2.64
Development of amenities such as restrooms, night lighting and electricity	23.44% 94	35.66% 143	34.41% 138	6.48% 26	401	2.76
Other	7.51% 25	6.91% 23	9.01% 30	76.58% 255	333	1.45

Q11 Would you like to be contacted regarding upcoming public meetings or workshops? (Please provide email address)

Answered: 201 Skipped: 221



City of Escanaba’s Recreation Advisory Board’s Resolution of Support for Final Adoption of the City of Escanaba Parks and Recreation Plan for 2021 through 2026

WHEREAS, the City of Escanaba’s Recreation Advisory Board has undertaken a planning process to determine the recreation and natural resource conservation needs and desires of its residents during a 5-year period covering the years of 2021 through 2026, and

WHEREAS, the Recreation Advisory Board is made up of representatives by citizens of the City, and

WHEREAS, the Board began the process of developing a community recreation plan in accordance with the most recent guidelines developed by the Department of Natural Resources and made available to local communities, and

WHEREAS, the public was given a well-advertised opportunity and reasonable accommodations to review the final draft plan for a period of at least 30 days, and

WHEREAS, the Board has developed the plan as a guideline for improving recreation and enhancing natural resource conservation for the City of Escanaba, and

NOW, THEREFORE BE IT RESOLVED the City of Escanaba’s Recreation Advisory Board hereby recommends to the City Council of Escanaba to adopt the final draft recreation plan as presented.

Yeas: Boardmembers Barb Chenier, Jennifer Gylock and Chairperson Joe Kaplan

Nays: None

Absent: Boardmember Jesse Herman and Vice Chairperson Patty Woerpel



Kimberly Peterson, City of Escanaba Recreation Director

Date: November 9, 2021

ESCANABA RECREATION ADVISORY BOARD
Meeting Minutes
Tuesday, November 9, 2021

The Escanaba Recreation Advisory Board met in regular session on Tuesday, November 9, 2021. Meeting was called to order at 6:00 p.m. in the Main Meeting Room at the Civic Center, 225 North 21st Street, Escanaba, MI 49829.

BOARDMEMBERS PRESENT: Chairperson Joe Kaplan, Vice Chairperson Patty Woerpel, Boardmembers Jennifer Gylock and Barb Chenier

OTHERS PRESENT: Recreation Director Kim Peterson, Recreation Assistant Brooks Bougie and City Council Liaison Karen Moore

BOARDMEMBERS ABSENT: Boardmember Jesse Herman

ANNOUNCEMENTS - N/A

APPROVAL/CORRECTION(S) TO MINUTES - REGULAR MEETING OF OCTOBER 12, 2021

A motion was made by Boardmember Chenier, seconded by Boardmember Gylock, to approve the meeting minutes for October 12, 2021. Motion was approved unanimously.

APPROVAL/ADJUSTMENTS TO THE AGENDA

A motion was made to accept the agenda as is by Vice Chairperson Woerpel, seconded by Boardmember Chenier. Motion was approved unanimously.

CONFLICT OF INTEREST DECLARATION – N/A

PUBLIC HEARING – Five-Year Recreation Plan 2021-2026

Julia Cogger with CUPPAD reviewed the draft plan.

Chairperson Kaplan opened the Public Hearing.

_____ , stated she would like to see a dedicated indoor pickleball court. She showed examples of other outdoor pickleball courts.

_____ stated he supported dedicated pickleball courts.

_____ stated she supported outdoor dedicated pickleball courts.

stated he would like to see Action Plan Pier 3 Restroom Facility and Marina Improvements moved from a Priority #3 to a Priority #2.

(See attached list of attendees for the Public Hearing).

Recreation Director Peterson read letters of support from citizens into the record in support of dedicated pickleball courts. (See attached letters).

Recreation Director Peterson stated administration met on the Aronson Island bridge. The bridge will need some construction work. However, discussions took place on adding boardwalks along the shoreline and ADA accessible fishing piers. This project is estimated at \$2 million.

Chairperson Kaplan closed the Public Hearing.

The Board by consensus agreed to move Action Plan Pier 3 Restroom Facility and Marina Improvements to a Priority #2.

The Board by consensus will add language for a larger project related to the ADA accessible boardwalks and ADA accessible fishing piers to the plan.

Chairperson Kaplan read a resolution into the record (attached) that needs action by the Board.

A motion was made by Boardmember Chenier, seconded by Boardmember Gylock to approve the resolution as written and submit to the City Council for their final approval and adoption of the Five-Year Recreation Plan 2021-2026. Motion was approved unanimously.

Note: Vice Chairperson Woerpel had another commitment and left the meeting at 6:30 p.m.

GENERAL PUBLIC COMMENT – N/A

UNFINISHED BUSINESS – N/A

NEW BUSINESS

North City Limits Non-Motorized Pathway Project.

Recreation Director Peterson stated construction of the \$1.3 million project has been completed with just a couple of minor things to iron out. Moving forward, the Engineering Department will get with MDOT on the final project sign off and submit reimbursements and project close out documents. Then the reimbursements will be submitted to the Michigan Department of Natural Resources Trust Fund Grant. A ribbon cutting will be needed upon final project completion with the Michigan Department of Natural Resources.

Recreation Director Peterson stated the Board wanted to look at the next section of non-motorized pathway to be completed, which is 3rd Avenue North separated path from Stephenson Avenue to North 10th Street. Cost estimate being approximately \$270,000.

Update on Civic Center Opening for Youth

Recreation Director Peterson stated that she has been in contact with the local health department monthly. The health departments stance is it's probably not a good idea to open up for students yet with the rate of Covid transmission within the community still being very high. Continued contact with the health department on a monthly basis will be done, but she does not foresee opening up for students until at least after the first of the year.

MISCELLANEOUS

Chairperson Kaplan mentioned that he would be moving out of the city limits and will legally not be able to hold his position on the board.

ADJOURNMENT

A motion was made by Boardmember Chenier, seconded by Boardmember Gylock, to adjourn with the time being 7:00 p.m. Motion approved unanimously.

Respectfully submitted,
Kim Peterson, Recreation Director

Joe Kaplan, Chairperson

Date

4/9896

Hi Kim

This letter is in regards to the upcoming recreation plan. Meeting Nov 9 2021. I've played racket sports all my life. Starting with handball, racket ball, tennis and now pickleball. Pickleball is a great sport for all ages. Its easy to learn but hard to master.

Its also fun, competitive, and a good workout. You generally play with a new partner each game which makes it pretty social. Plus its the fastest growing sport in North America. Pickleball has become very popular and the people of Escanaba Area need a dedicated indoor facility to fully enjoy this popular sport. Pickleballs doesn't like the rain, wind and cold weather, we need an indoor facility.

I support any and all action to enhance pickleball especially an indoor type. Board members jump in with both feet and make it happen (dedicated indoor pickleball facility). Thank you

Sincerely

⏪ Reply all ⌵ Delete 🗑️ Junk 🚫 Block ⋮

Dedicated pickleball courts

EA
Tue 11/9/2021 12:50 PM
To: Recreation

👍 ↶ ⏪ → ⋮

I just want to let you know that I am in favor of dedicated pickleball courts in Escanaba. I can't attend the meeting tonight but I need to put in my vote for the courts. Please consider putting this on the agenda.

Reply | Reply all | Forward

11/9/21, 5:38 PM

Mail - Kim Peterson - Outlook

Pickleball

Tue 11/9/2021 5:02 PM

To: Recreation <recreation@escanaba.org>

I'm sorry I can't attend the meeting tonight. I would like to say that I fully support having dedicated pickleball courts in Escanaba. I live between Escanaba and Gladstone but I have always played in Escanaba. Please consider making Pickleball a priority in the recreation budget.

Sent from my iPhone

Reply all Delete Junk Block ...

Gladstone

S

Pickleball courts

RM Tue 11/9/2021 2:54 PM

To: Recreation

Dear Ms. Kim Peterson,
Thank you to your committee for considering pickleball courts in Escanaba for the future. Pickleball is a fast growing sport for young and retired people. Please try to expand the times and locations for pickleball in the future. We especially need more indoor court time during winter hours.

Pickleball player since 2015

Sent from my iPhone

Reply | Reply all | Forward

Like Reply Reply all Forward ...

Pickleball

PH Tue 11/9/2021 1:16 PM

To: Recreation

My husband and I have been playing 4 times a week. He tried it on vacation and really enjoys playing. It's rapidly growing and can be played at any age. Some states have high school students playing as a sport. We need specific courts to get more involved. Hopefully a plan will include this great social and recreational sport.

Sent from my iPhone

Reply | Reply all | Forward

Like Reply Reply all Forward ...

⏪ Reply all ▾ 🗑 Delete 🗑 Junk 🚫 Block ⋮

*Not a member
ESKY*

Pickle ball courts

PG Tue 11/9/2021 2:37 PM

To: Recreation

I am sorry cannot make recreation meeting on 5 year plan. Pickle ball is the fastest growing sport, we have so many tennis courts that have little use. No reason cannot be converted to full time courts for pickle ball, I am talking permanent nets and one set of lines.
Thank you

Sent from my iPhone

[Reply](#) | [Reply all](#) | [Forward](#)

👍 ↶ ⏪ → ⋮

⏪ Reply all ▾ 🗑 Delete 🗑 Junk 🚫 Block ⋮

Pickleball

JH Tue 11/9/2021 1:27 PM

To: Recreation

Hello Kim,
We are in desperate need of PB courts. It is upcoming sport going strong. It will bring revenue to the community in so many ways
Hotel, restaurants and the town itself.
Jan and Bob Haim

Sent from my iPhone

[Reply](#) | [Reply all](#) | [Forward](#)

👍 ↶ ⏪ → ⋮



[Reply all](#) [Delete](#) [Junk](#) [Block](#) ...

November 9, 2021

PS
Tue 11/9/2021 3:26 PM
To: Recreation

November 9, 2021

To the Escanaba Area Recreation Department Staff & Board Members,

Due to a conflict, I am not able to make tonight's meeting but would like to express strong support for dedicated pickleball courts in Escanaba through this email. Pickleball is America's fastest growing sport & is very popular among people over the age of 50, but is also rapidly growing among younger people. It is a source of exercise & a way for people to meet others & become socially involved.

There is a large number of pickleball participants in the Escanaba/Gladstone area & numbers are increasing rapidly. It would be fabulous to have some outdoor dedicated pickleball courts. I also see a need for more indoor courts than the three at the Civic Center. The hours for play are limited & three courts only accommodate 12 players.

It would be fabulous if there was dedicated outdoor pickleball courts & more indoor courts that would serve the citizens of the community.

Thank you for your consideration,
Patti Stropich

Sent from my iPad

[Reply](#) | [Reply all](#) | [Forward](#)

ESCANABA RECREATION PLAN | STAKEHOLDER MEETING
8.8.2021 + 9.14.2021

JULY 21, 2021

City of Escanaba 5-Year Recreation Plan Update

INVITATION TO JOIN THE STAKEHOLDER TEAM

Dear

We are writing to invite you to join a select group of local representatives to participate in a 5-yr Recreation Plan update for the City of Escanaba. At this time there are two meetings planned: the first is on Tuesday, August 10th from 4:30-5:30PM at the Escanaba City Hall and the second is on Tuesday, September 14th from 4:30-5:30PM also at the Escanaba City Hall. These are invitation only events structured to gain valuable insight from local volunteers, community members, and recreation leaders within the community. The meetings will be immediately followed by the Escanaba Recreation Advisory Board Meeting.

I am a recreation planner with the Central U.P. Planning and Development Commission and will be leading the discussion. The first meeting will feature a presentation of the community recreation survey results, a summary of recreation goals and values derived from the survey responses, and a working list of potential recreation projects to be completed within the City of Escanaba. This presentation is designed for interaction and comments will be encouraged. Materials will be provided to you via email for review one week prior to the meeting.

The second meeting will feature a presentation of any updates that reflect comments from the August session and a completed draft plan for review. If deemed necessary, we will schedule an additional meeting to make any changes before finalizing the draft.

Once adopted by the City Council the 5-year Recreation Plan will serve as a guide for community officials to prioritize recreation projects for implementation within the community. The 5-year Recreation Plan is also required by the Michigan DNR to apply for grant funding. This plan will hopefully unlock a community defined list of recreation priorities that will shape the future of recreation within Escanaba.

To confirm your attendance, please RSVP by responding to my email. If you are not available but wish to review the materials and provide comment independently, please email me and I can forward them to you. If you have any questions, please feel free to send me an email at jcogger@cuppadd.org or call 906.280.0820.

We greatly appreciate your consideration to attend and are excited by the prospect of what we can do together.

Best Regards,
Julia Cogger

ESCANABA RECREATION PLAN

[This email has been sent by an external sender, please use caution]

Hello,

I am unable to make the meeting Tuesday as I have prior engagements but I would love to share some of my thoughts.

The PowerPoint is great and well put together! I will tell you, I have young children and we are active so my input is likely bias towards young families.

I work at the hospital and do a lot of hiring as well. Mostly people from outside our area. Here are some things I highlight when I tour our area and what has drawn people here.

1. A lot of beautiful beach/lake access between Escanaba and Gladstone
2. Great local food
3. Local brewery with dog park
4. Walking trails around the area and even a great new bike/walking path along the lake from Escanaba to Gladstone
5. Lots of great, well-kept parks for children
6. Safe area all around

Some things that could be better

1. Better use of our Ludington park. It is nice that there is so much land but there needs to be local food closer to down there with a nice seating area that will draw people to stop here on boats. Easier to grab a bite to eat and sit on their patio at the lake. So much potential down there that could attract more life.
 - a. Adding a splash pad around this area – on the list to be done, great!
 - b. Adding an outdoor skating rink with lights and a small heating building (could be something like Bark River has)
 - c. I saw that adding a kayak launch to Aronson Island is on the current project list – wonderful!
 - d. Adding electric to the pavilion so it can be better utilized is on the list – again, wonderful!
 - e. Updating the tennis/basketball/volleyball courts down there
 - f. Adding a bocce ball place would be nice but likely not as well used as the above and the money for this could be used for those.
2. Better use of the Marina
3. More things to do. I don't know exactly how this would work but a trampoline park and/or rock climbing wall. Maybe partnering with the YMCA to help support these things in our community. Just more fun things to do as a family. These could even be attached to the current putt putt course or bowling alley as a "one stop game and fun" location. This way it is already covered with staffing.

I understand that certain things need to be done because of grants or nature preserve. I feel that getting the biggest use for money will be the items that will be seen such as the items listed above. I know most of our Escanaba population is older but migratory bird enhancement doesn't normally bring people to the area or is a very big selling point for young families. This could likely steer funds toward other attractions.

I loved seeing the PowerPoint and the amazing work that is being done. I am excited to see our downtown thrive and become more of an attraction, as it should be with all of the beautiful views. I look forward to being on this recreation planning committee.

Thank you,



[This email has been sent by an external sender, please use caution]

Hi Julia,

I was wondering about a couple undefined or overlooked items within your powerpoint.

first; boundary "markings" for all the assets which are listed. (I can provide more detail as needed but with the recent declaration by the city to "enforce encroachments", this is again on top of my list)

second; The Portage Marsh access site not being listed within the assets. Located on East side of Lake Shore Drive and about 300' South of the athletic field.

I look forward to the first meeting

Regards

[This email has been sent by an external sender, please use caution]

Julia,

Again, my apologies for not attending Tuesday's meeting. I'm looking forward to September's meeting.

My comments on the presentation -

First - in general I would like the Recreation Plan to consider two things... 1) Arts and Culture events and activities and 2) Events.

Recreation is about what folks do in their leisure time. Nature is crucial but not exclusive in U.P. recreation. In the Community Input from the survey Art+History were mentioned in the "What do you value about Escanaba's Recreation opportunities?" - and I do understand that they weren't in the top 7 replies). I know art galleries (retail and nonprofit), the library, and museums (like the historical society) are often visitor destinations as well as frequented by residents.

CONTINUED...

It's clear that Events+Music were the 3rd highest survey response to "What do you think of when someone mentions "recreation". The City sponsors a lot of events/concerts. Music Mondays are "relatively" new but now well established. MarinaFest and Rock the Dock events are popular. The Waterfront Art Festival is a staple in our summer events as is the Cruisin' Classics show. The City Band is a fixture in our community and I think we need to incorporate references to that kind of (already accepted) arts and culture in our Recreation plan. I'd be happy to brainstorm how it gets phrased but I truly think it belongs. Perhaps we should touch on partnerships that we encourage or rely on for these kind of events - like with the Chamber of Commerce, the Marina, and the Bonifas Arts Center as I know the City doesn't control the resources for these events BUT these events DO make the community more attractive as a place to live for young people, to raise a family, and to enjoy one's retirement.

Second - my take on the slides were that they were well done. I like the demographic comparison. Definitely number the slides, pls. Now... to comments about the slides...

- 1) On the community input for "What would you like to change about Escanaba's recreation opportunities?" there was no header/title on the item that scored 33 votes - first slide, top row, middle photo. What was it? And... the photo to its left (Add beach slide +/- or splash pad) - how many votes did it score?
- 2) What does SCORP stand for?
- 3) Give the goal I think that adding arts and culture "activities" and "events" would fit right in ("cultural assets" that "meet the fun, relaxation and health needs..." And in Goal 1 - Host community events... and "Year round recreation opportunities including indoor community assets"
- 4) The Safety slides are great and mostly easy to understand. I want to learn more about how to separate (without a fence) public and private properties.
- 5) The Slide on natural access control sparked a question - are the ramps from Lake Shore Drive to the bottom of Ludington Park generally acceptable? Related questions include would steps be better or would a switchbacked ramp with a grade more amenable to a wheelchair be better? Okay - random. Sorry.

Also, I write grants for the Bonifas Arts Center and I'm willing to help the city write grants to achieve goal 2, "Provide educational opportunities for the community to learn more about the great lakes and local ecosystems"

That's what I came up with. Would love to chat more about this.
Thanks for including me!

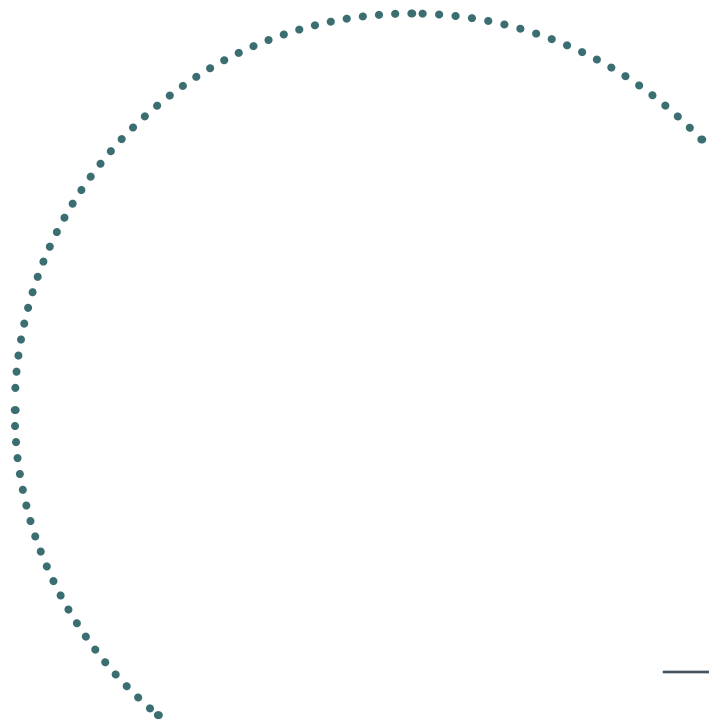

THANK YOU

Appendix B

DNR GRANT HISTORY

PROJECT NUMBER: 26-01215

SAND ISLAND BOAT LAUNCH

Project Year: 1981

Project Description: Develop launch ramp, parking area with curb stops, skid pier, vault toilets, access road and LWCF sign

Grant Amount: \$28,290.63

Project Status: Closed

PROJECT NUMBER: 26-01264

WEBSTER PARK SHELTER HOUSE

Project Year: 1983

Project Description: Demolition of existing shelter, construction of new shelter house with utilities, removal of overhead power lines, parking improvements, fencing and barrier posts, LWCF sign

Grant Amount: \$40,533.00

Project Status: Closed

PROJECT NUMBER: 26-01328

LUDINGTON PARK RESTROOMS

Project Year: 1984

Project Description: Develop toilet building, site, + utilities

Grant Amount: \$50,597.00

Project Status: Closed

PROJECT NUMBER: TF87-240

ESCANABA MUNICIPAL MARINA

Project Year: 1987

Project Description: Install 500' floating head pier systems, utilities, demolition and replacement of revetment wall.

Grant Amount: \$300,000

Project Status: Closed

Project Number: 26-01481

Escanaba Municipal Beach

Project Year: 1988

Project Description: Development of concrete rubble on beachfront, beach fill, fencing, boardwalk, beach grass, landscaping + parking lots at Escanaba Municipal Beach

Grant Amount: \$50,037.00

Project Status: Closed

PROJECT NUMBER: BF89-555

LUDINGTON PARK

Project Year: 1989

Project Description: Replace electric and potable water systems to bandshell and tennis courts

Grant Amount: \$37,500.00

Project Status: Closed

PROJECT NUMBER: TF90-365

WALCH ESTATE PROPERTY

Project Year: 1990

Project Description: Acquire 240 acres currently leased by the City to preserve wetlands and cross-country ski path.

Grant Amount: \$22,500.00

Project Status: Closed

PROJECT NUMBER: BF91-329

LUDINGTON PARK PLAYGROUND

Project Year: 1991

Project Description: Renovate and replace playground equipment and related equipment at the tot lot and municipal beach

Grant Amount: \$22,500.00

Project Status: Closed



DNR GRANT HISTORY

PROJECT NUMBER: TF97-088

LUDINGTON PARK BIKE PATH/WALKWAY PROJECT

Project Year: 1997

Project Description: Construct 1,300 ft bike path/walkway providing access to historical and interpretive features

Grant Amount: \$17,500.00

Project Status: Closed

Project Number: CM99-281

Ludington Park Pathway and Parking

Project Year: 1999

Project Description: Renovate Aronson Isl. Bike/Pedestrian Pathway + upgrade bandshell parking lot

Grant Amount: \$131,250.00

Project Status: Closed

PROJECT NUMBER: TF99-384

ESCANABA RIVERFRONT PROPERTY ACQUISITION

Project Year: 1999

Project Description: Acquisition in fee simple of about 12 acres of riverfront property at the mouth of the Escanaba River for construction of a large capacity small boat launch site for access to the Escanaba River and Little Bay de Noc

Grant Amount: \$102,750.00

Project Status: Closed

PROJECT NUMBER: TF00-185

LUDINGTON BEACH HOUSE RENOVATION

Project Year: 2000

Project Description: Renovation of Ludington Park beach house to meet current standards for safety and accessibility

Grant Amount: \$192,500.00

Project Status: Closed

PROJECT NUMBER: 26-016XX1

SOCCER FIELD COMPLEX

Project Year: 2002

Project Description: Develop 2 regulation soccer fields on S. 28th to serve entire region

Grant Amount: \$37,500.00

Project Status: Withdrawn

PROJECT NUMBER: RP13-481

LUDINGTON PARK TENNIS COURTS RENOVATION

Project Year: 2013

Project Description: ADA access to courts/bathrooms, and renovate 4 tennis and 1 basketball courts, ADA drinking fountain and picnic tables

Grant Amount: \$42,000.00

Project Status: Closed

Project Number: RP16-0133

Escanaba Marketplace Play and Park Structure

Project Year: 2016

Project Description: Develop new play equipment and access pathways

Grant Amount: \$45,000.00

Project Status: Closed

**APPENDIX L:
POST COMPLETION SELF-INSPECTION REPORT**



Michigan Department of Natural Resources - Grants Management

PUBLIC OUTDOOR RECREATION GRANT

POST-COMPLETION SELF-CERTIFICATION REPORT

*This information required under authority of Part 19, PA 451 of 1994, as amended;
the Land and Water Conservation Fund Act of 1965, 78 Stat. 897 (1964); and Part 715, of PA 451 of 1994, as amended.*

GRANT TYPE:
(Please select one)

- MICHIGAN NATURAL RESOURCES TRUST FUND CLEAN MICHIGAN INITIATIVE
 LAND AND WATER CONSERVATION FUN RECREATION PASSPORT BOND FUND

GRANTEE: City of Escanaba

PROJECT NUMBER: TF00-185 PROJECT TYPE: Development

PROJECT TITLE: Ludington Park Beach House Renovation

PROJECT SCOPE: Renovations, walkways, site work + utilities

TO BE COMPLETED BY LOCAL GOVERNMENT AGENCY (GRANTEE)

Name of Agency (Grantee) <u>City of Escanaba</u>	Contact Person <u>Kim Peterson</u>	Title <u>Recreation Dir.</u>
Address <u>410 Ludington street</u>	Telephone <u>906-786-4141</u>	
City, State, ZIP <u>Escanaba MI 49829</u>	Email <u>kpeterson@escanaba.org</u>	

SITE DEVELOPMENT

Any change(s) in the facility type, site layout, or recreation activities provided? If yes, please describe change(s). Yes No

Has any portion of the project site been converted to a use other than outdoor recreation? If yes, please describe what portion and describe use. (This would include cell towers and any non-recreation buildings.) Yes No

Are any of the facilities obsolete? If yes, please explain. Yes No

SITE QUALITY

Is there a park entry sign which identifies the property or facility as a public recreation area? If yes, please provide a photograph of the sign. If no, please explain. Yes No

Are the facilities and the site being properly maintained? If no, please explain. Yes No

Is vandalism a problem at this site? If yes, explain the measures being taken to prevent or minimize vandalism. Yes No

Is maintenance scheduled on a regular basis? If yes, give schedule. If no, please explain. Yes No
General Fund - Seasonal + daily activities when being used.

GENERAL

Is a Program Recognition plaque permanently displayed at the site? If yes, please provide a photograph. (Not required for Bond Fund Grants) Yes No N/A

Is any segment of the general public restricted from using the site or facilities? (i.e. resident only, league only, boaters only, etc.) If yes, please explain. Yes No

Is a fee charged for use of the site or facilities? If yes, please provide fee structure. Yes No

What are the hours and seasons for availability of the site?
Seasonal Summer 12:00 noon - 7:00 pm Daily

COMMENTS (ATTACH SEPARATE SHEET IF MORE SPACE IS NEEDED)

(Empty space for comments)

CERTIFICATION

I do hereby certify that I am duly elected, appointed and/or authorized by the Grantee named above and that the information and answers provided herein are true and accurate to the best of my personal knowledge, information and belief.

<i>Kim Peterson</i> Please print	<i>Kim Peterson</i> Grantee Authorized Signature	<i>10/7/21</i> Date
<i>Bruce Baugie</i> Please print	<i>Bruce Baugie</i> Witness Signature	<i>10/7/21</i> Date

Send completed report to:
**POST COMPLETION GRANT INSPECTION REPORTS
 GRANTS MANAGEMENT
 MICHIGAN DEPARTMENT OF NATURAL RESOURCES
 PO BOX 30425
 LANSING MI 48909-7925**

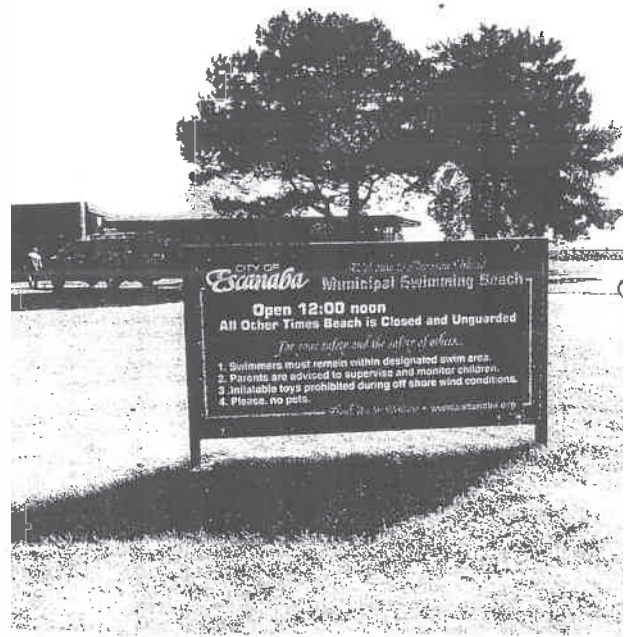

**APPENDIX L:
POST COMPLETION SELF-INSPECTION REPORT**



Michigan Department of Natural Resources - Grants Management
**PUBLIC OUTDOOR RECREATION GRANT
POST-COMPLETION SELF-CERTIFICATION REPORT**

*This information required under authority of Part 19, PA 451 of 1994, as amended;
the Land and Water Conservation Fund Act of 1965, 78 Stat. 897 (1964); and Part 715, of PA 451 of 1994, as amended.*

GRANT TYPE: (Please select one) MICHIGAN NATURAL RESOURCES TRUST FUND CLEAN MICHIGAN INITIATIVE
 LAND AND WATER CONSERVATION FUN RECREATION PASSPORT BOND FUND

GRANTEE: City of Escanaba

PROJECT NUMBER: TF90-365 PROJECT TYPE: Acquisition

PROJECT TITLE: Walch Estate Property

PROJECT SCOPE: Acquire 240 acres of land

TO BE COMPLETED BY LOCAL GOVERNMENT AGENCY (GRANTEE)		
Name of Agency (Grantee)	Contact Person	Title
City of Escanaba	Kim Peterson	Recreation Dir.
Address 410 Ludington Street	Telephone 906-126-4141	
City, State, ZIP Escanaba MI 49829	Email kpeterson@escanaba.org	

SITE DEVELOPMENT
Any change(s) in the facility type, site layout, or recreation activities provided? If yes, please describe change(s). Yes No

Has any portion of the project site been converted to a use other than outdoor recreation? If yes, please describe what portion and describe use. (This would include cell towers and any non-recreation buildings.) Yes No

Are any of the facilities obsolete? If yes, please explain. Yes No

SITE QUALITY
Is there a park entry sign which identifies the property or facility as a public recreation area? If yes, please provide a photograph of the sign. If no, please explain. Yes No

Are the facilities and the site being properly maintained? If no, please explain. Yes No

Is vandalism a problem at this site? If yes, explain the measures being taken to prevent or minimize vandalism. Yes No

Is maintenance scheduled on a regular basis? If yes, give schedule. If no, please explain. Yes No
General fund and volunteers on site on a weekly basis.

GENERAL

Is a Program Recognition plaque permanently displayed at the site? If yes, please provide a photograph. (Not required for Bond Fund Grants) Yes No N/A

Is any segment of the general public restricted from using the site or facilities? (i.e. resident only, league only, boaters only, etc.) If yes, please explain. Yes No

Is a fee charged for use of the site or facilities? If yes, please provide fee structure. Yes No

What are the hours and seasons for availability of the site?
All the time 24/7

COMMENTS (ATTACH SEPARATE SHEET IF MORE SPACE IS NEEDED)

CERTIFICATION

I do hereby certify that I am duly elected, appointed and/or authorized by the Grantee named above and that the information and answers provided herein are true and accurate to the best of my personal knowledge, information and belief.

Kim Peterson Please print [Signature] Grantee Authorized Signature 10/1/21 Date

Brooks Bougie Please print [Signature] Witness Signature 10/1/21 Date

Send completed report to: **POST COMPLETION GRANT INSPECTION REPORTS
 GRANTS MANAGEMENT
 MICHIGAN DEPARTMENT OF NATURAL RESOURCES
 PO BOX 30425
 LANSING MI 48909-7925**





**APPENDIX L:
POST COMPLETION SELF-INSPECTION REPORT**

Michigan Department of Natural Resources - Grants Management
PUBLIC OUTDOOR RECREATION GRANT

POST-COMPLETION SELF-CERTIFICATION REPORT

*This information required under authority of Part 19, PA 451 of 1994, as amended;
the Land and Water Conservation Fund Act of 1965, 78 Stat. 897 (1964); and Part 715, of PA 451 of 1994, as amended.*

GRANT TYPE: (Please select one)
 MICHIGAN NATURAL RESOURCES TRUST FUND CLEAN MICHIGAN INITIATIVE
 LAND AND WATER CONSERVATION FUN RECREATION PASSPORT BOND FUND

GRANTEE: City of Escanaba

PROJECT NUMBER: CM 99-281 **PROJECT TYPE:** Development

PROJECT TITLE: Ludington Park Pathway + Parking

PROJECT SCOPE: Pathway + bridge renovations and Bandshell parking

TO BE COMPLETED BY LOCAL GOVERNMENT AGENCY (GRANTEE)

Name of Agency (Grantee) <u>City of Escanaba</u>	Contact Person <u>Kim Peterson</u>	Title <u>Recreation Dir.</u>
Address <u>410 Ludington Street</u>	Telephone <u>906-186-4141</u>	
City, State, ZIP <u>Escanaba MI 49829</u>	Email <u>kpeterson@escanaba.org</u>	

SITE DEVELOPMENT

Any change(s) in the facility type, site layout, or recreation activities provided? If yes, please describe change(s). Yes No

Has any portion of the project site been converted to a use other than outdoor recreation? If yes, please describe what portion and describe use. (This would include cell towers and any non-recreation buildings.) Yes No

Are any of the facilities obsolete? If yes, please explain. Yes No

SITE QUALITY

Is there a park entry sign which identifies the property or facility as a public recreation area? If yes, please provide a photograph of the sign. If no, please explain. Yes No

Are the facilities and the site being properly maintained? If no, please explain. Yes No

Is vandalism a problem at this site? If yes, explain the measures being taken to prevent or minimize vandalism. Yes No

Is maintenance scheduled on a regular basis? If yes, give schedule. If no, please explain. Yes No

General Fund. Workers on site Monday to Friday.

GENERAL

Is a Program Recognition plaque permanently displayed at the site? If yes, please provide a photograph. (Not required for Bond Fund Grants) Yes No N/A

Is any segment of the general public restricted from using the site or facilities? (i.e. resident only, league only, boaters only, etc.) If yes, please explain. Yes No

Is a fee charged for use of the site or facilities? If yes, please provide fee structure. Yes No

What are the hours and seasons for availability of the site?

Daily 7:00 a.m. - 11:00 p.m.

COMMENTS (ATTACH SEPARATE SHEET IF MORE SPACE IS NEEDED)

CERTIFICATION

I do hereby certify that I am duly elected, appointed and/or authorized by the Grantee named above and that the information and answers provided herein are true and accurate to the best of my personal knowledge, information and belief.

Kim Peterson
Please print

[Signature]
Grantee Authorized Signature

10/7/21
Date

Brooks Baugie
Please print

[Signature]
Witness Signature

10/7/21
Date

Send completed report to:

POST COMPLETION GRANT INSPECTION REPORTS
GRANTS MANAGEMENT
MICHIGAN DEPARTMENT OF NATURAL RESOURCES
PO BOX 30425
LANSING MI 48909-7925

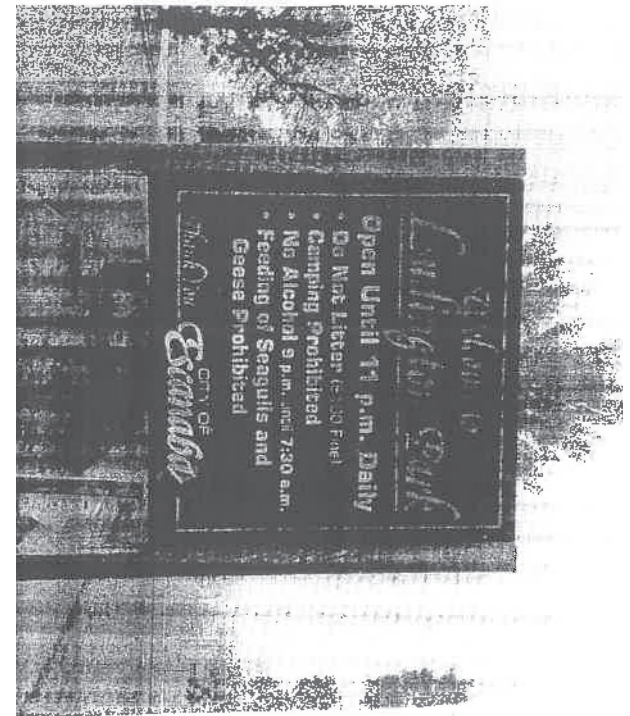

**APPENDIX L:
POST COMPLETION SELF-INSPECTION REPORT**



Michigan Department of Natural Resources - Grants Management
**PUBLIC OUTDOOR RECREATION GRANT
POST-COMPLETION SELF-CERTIFICATION REPORT**

*This information required under authority of Part 19, PA 451 of 1994, as amended,
the Land and Water Conservation Fund Act of 1965, 78 Stat. 897 (1964); and Part 715, of PA 451 of 1994, as amended.*

GRANT TYPE: (Please select one)
 MICHIGAN NATURAL RESOURCES TRUST FUND CLEAN MICHIGAN INITIATIVE
 LAND AND WATER CONSERVATION FUN RECREATION PASSPORT BOND FUND

GRANTEE: City of Escanaba

PROJECT NUMBER: TF87-240 **PROJECT TYPE:** Development

PROJECT TITLE: Escanaba municipal marina

PROJECT SCOPE: Install 500' floating head pier system

To Be Completed By Local Government Agency (GRANTEE)		
Name of Agency (Grantee)	Contact Person	Title
<u>City of Escanaba</u>	<u>Kim Peterson</u>	<u>Recreation Dir.</u>
Address	Telephone	
<u>410 Ludington Street</u>	<u>906-126-4141</u>	
City, State, ZIP	Email	
<u>Escanaba MI 49829</u>	<u>kpeterson@escanaba.org</u>	
SITE DEVELOPMENT		
Any change(s) in the facility type, site layout, or recreation activities provided? If yes, please describe change(s).		<input type="checkbox"/> Yes <input checked="" type="checkbox"/> No
Has any portion of the project site been converted to a use other than outdoor recreation? If yes, please describe what portion and describe use. (This would include cell towers and any non-recreation buildings.)		<input type="checkbox"/> Yes <input checked="" type="checkbox"/> No
Are any of the facilities obsolete? If yes, please explain.		<input type="checkbox"/> Yes <input checked="" type="checkbox"/> No
SITE QUALITY		
Is there a park entry sign which identifies the property or facility as a public recreation area? If yes, please provide a photograph of the sign. If no, please explain.		<input checked="" type="checkbox"/> Yes <input type="checkbox"/> No
Are the facilities and the site being properly maintained? If no, please explain.		<input checked="" type="checkbox"/> Yes <input type="checkbox"/> No



Is vandalism a problem at this site? If yes, explain the measures being taken to prevent or minimize vandalism. Yes No

Is maintenance scheduled on a regular basis? If yes, give schedule. If no, please explain. Yes No

Marina Fund. Staffing is on site daily during season and weekly checks afterwards.

GENERAL

Is a Program Recognition plaque permanently displayed at the site? If yes, please provide a photograph. (Not required for Bond Fund Grants) Yes No N/A

Is any segment of the general public restricted from using the site or facilities? (i.e. resident only, league only, boaters only, etc.) If yes, please explain. Yes No

Is a fee charged for use of the site or facilities? If yes, please provide fee structure. Yes No

Seasonal and transient fees by boaters

What are the hours and seasons for availability of the site?

24 hours May-October

COMMENTS (ATTACH SEPARATE SHEET IF MORE SPACE IS NEEDED)

Project scope - Demolition and replacement of revetment wall.

CERTIFICATION

I do hereby certify that I am duly elected, appointed and/or authorized by the Grantee named above and that the information and answers provided herein are true and accurate to the best of my personal knowledge, information and belief.

Kim Peterson
Please print
[Signature]
Grantee Authorized Signature
10/9/21
Date

Bruce Bougie
Please print
[Signature]
Witness Signature
10/9/21
Date

Send completed report to:
POST COMPLETION GRANT INSPECTION REPORTS
GRANTS MANAGEMENT
MICHIGAN DEPARTMENT OF NATURAL RESOURCES
PO BOX 30425
LANSING MI 48909-7925

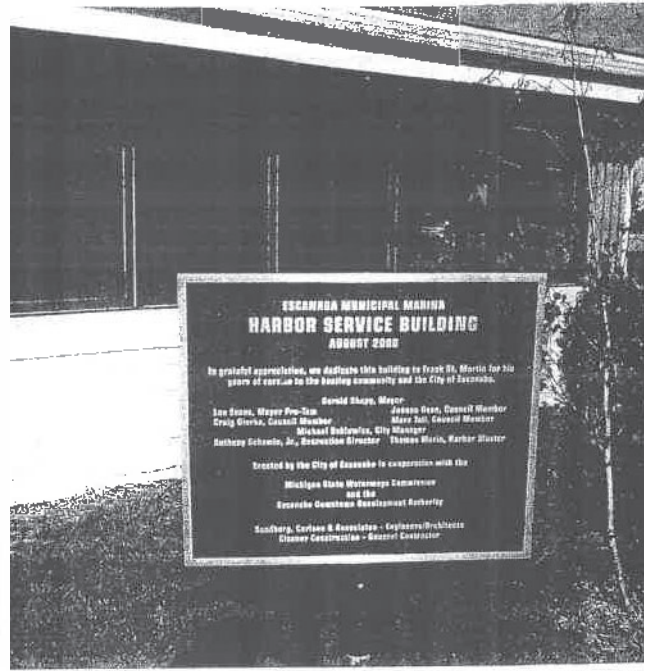



**APPENDIX L:
POST COMPLETION SELF-INSPECTION REPORT**

Michigan Department of Natural Resources - Grants Management
PUBLIC OUTDOOR RECREATION GRANT
POST-COMPLETION SELF-CERTIFICATION REPORT

This information required under authority of Part 19, PA 451 of 1994, as amended;
the Land and Water Conservation Fund Act of 1965, 78 Stat. 897 (1964); and Part 715, of PA 451 of 1994, as amended.

GRANT TYPE: (Please select one) MICHIGAN NATURAL RESOURCES TRUST FUND CLEAN MICHIGAN INITIATIVE
 LAND AND WATER CONSERVATION FUN RECREATION PASSPORT BOND FUND

GRANTEE: City of Escanaba

PROJECT NUMBER: IF97-088 PROJECT TYPE: Development

PROJECT TITLE: Ludington Park Bike Path/Walkway Project

PROJECT SCOPE: Construct 1300' bike path/walkway

TO BE COMPLETED BY LOCAL GOVERNMENT AGENCY (GRANTEE)		
Name of Agency (Grantee)	Contact Person	Title
<u>City of Escanaba</u>	<u>Kim Peterson</u>	<u>Recreation Dir.</u>
Address	Telephone	
<u>910 Ludington Street</u>	<u>906-186-4141</u>	
City, State, ZIP	Email	
<u>Escanaba MI 49829</u>	<u>kpeterson@escanaba.org</u>	
SITE DEVELOPMENT		
Any change(s) in the facility type, site layout, or recreation activities provided? If yes, please describe change(s).		<input type="checkbox"/> Yes <input checked="" type="checkbox"/> No
Has any portion of the project site been converted to a use other than outdoor recreation? If yes, please describe what portion and describe use. (This would include cell towers and any non-recreation buildings.)		<input type="checkbox"/> Yes <input checked="" type="checkbox"/> No
Are any of the facilities obsolete? If yes, please explain.		<input type="checkbox"/> Yes <input checked="" type="checkbox"/> No
SITE QUALITY		
Is there a park entry sign which identifies the property or facility as a public recreation area? If yes, please provide a photograph of the sign. If no, please explain.		<input checked="" type="checkbox"/> Yes <input type="checkbox"/> No
Are the facilities and the site being properly maintained? If no, please explain.		<input checked="" type="checkbox"/> Yes <input type="checkbox"/> No

Is vandalism a problem at this site? If yes, explain the measures being taken to prevent or minimize vandalism. Yes No
 Currently looking at installing cameras and additional lighting

Is maintenance scheduled on a regular basis? If yes, give schedule. If no, please explain. Yes No
 General Fund - Staff is on site Monday - Friday

GENERAL

Is a Program Recognition plaque permanently displayed at the site? If yes, please provide a photograph. (Not required for Bond Fund Grants) Yes No N/A

Is any segment of the general public restricted from using the site or facilities? (i.e. resident only, league only, boaters only, etc.) If yes, please explain. Yes No

Is a fee charged for use of the site or facilities? If yes, please provide fee structure. Yes No

What are the hours and seasons for availability of the site?
 Daily 7:00 a.m. - 11:00 p.m.

COMMENTS (ATTACH SEPARATE SHEET IF MORE SPACE IS NEEDED)

CERTIFICATION

I do hereby certify that I am duly elected, appointed and/or authorized by the Grantee named above and that the information and answers provided herein are true and accurate to the best of my personal knowledge, information and belief.

Kim Peterson [Signature] 10/7/21
 Please print Grantee Authorized Signature Date

Brooks Bougie [Signature] 10/7/21
 Please print Witness Signature Date

Send completed report to:
 POST COMPLETION GRANT INSPECTION REPORTS
 GRANTS MANAGEMENT
 MICHIGAN DEPARTMENT OF NATURAL RESOURCES
 PO BOX 30425
 LANSING MI 48909-7925

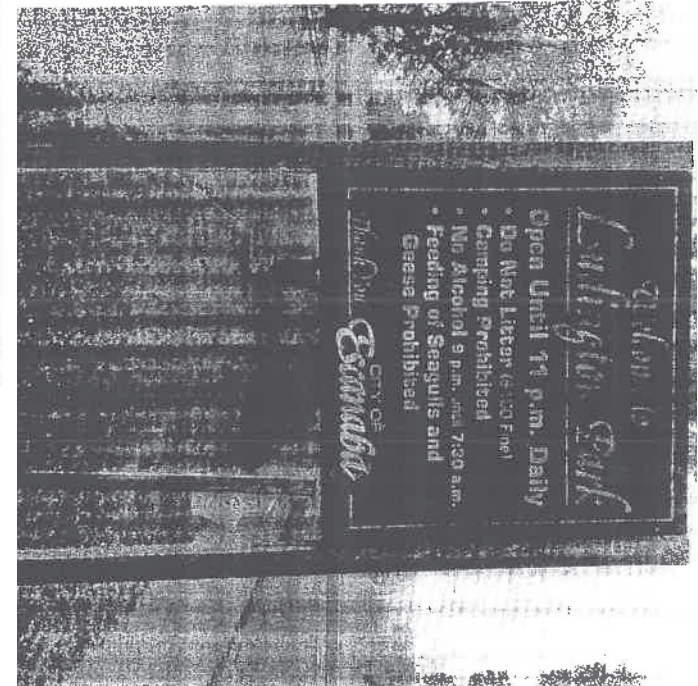

**APPENDIX L:
POST COMPLETION SELF-INSPECTION REPORT**



Michigan Department of Natural Resources - Grants Management
**PUBLIC OUTDOOR RECREATION GRANT
POST-COMPLETION SELF-CERTIFICATION REPORT**

*This information required under authority of Part 19, PA 451 of 1994, as amended,
the Land and Water Conservation Fund Act of 1965, 78 Stat. 897 (1964); and Part 715, of PA 451 of 1994, as amended.*

GRANT TYPE: (Please select one) MICHIGAN NATURAL RESOURCES TRUST FUND CLEAN MICHIGAN INITIATIVE
 LAND AND WATER CONSERVATION FUN RECREATION PASSPORT BOND FUND

GRANTEE: City of Escanaba

PROJECT NUMBER: 26-01264 PROJECT TYPE: Development

PROJECT TITLE: Webster Park Shelter House

PROJECT SCOPE: Demolition of shelter and construction of shelter.

TO BE COMPLETED BY LOCAL GOVERNMENT AGENCY (GRANTEE)	
Name of Agency (Grantee) <u>City of Escanaba</u>	Contact Person <u>Kim Peterson</u> Title <u>Recreation Dir.</u>
Address <u>410 Ludington Street</u>	Telephone <u>906-126-4141</u>
City, State, ZIP <u>Escanaba MI 49829</u>	Email <u>k.peterson@escanaba.org</u>

SITE DEVELOPMENT
Any change(s) in the facility type, site layout, or recreation activities provided?
If yes, please describe change(s). Yes No

Has any portion of the project site been converted to a use other than outdoor recreation? If yes, please describe what portion and describe use. (This would include cell towers and any non-recreation buildings.) Yes No

Are any of the facilities obsolete? If yes, please explain. Yes No

SITE QUALITY
Is there a park entry sign which identifies the property or facility as a public recreation area?
If yes, please provide a photograph of the sign. If no, please explain. Yes No

Are the facilities and the site being properly maintained? If no, please explain. Yes No

Is vandalism a problem at this site? If yes, explain the measures being taken to prevent or minimize vandalism. Yes No

Is maintenance scheduled on a regular basis? If yes, give schedule. If no, please explain. Yes No

General Fund. Staff on site Monday - Saturday during season. Monthly checks of facilities

GENERAL

Is a Program Recognition plaque permanently displayed at the site? If yes, please provide a photograph. (Not required for Bond Fund Grants) Yes No N/A

Is any segment of the general public restricted from using the site or facilities? (i.e. resident only, league only, boaters only, etc.) If yes, please explain. Yes No

Is a fee charged for use of the site or facilities? If yes, please provide fee structure. Yes No

What are the hours and seasons for availability of the site? Saturday 12:00 p.m. - 5:00 p.m.

Seasonal - Summer M-F 12:00 p.m. - 7:00 p.m.

COMMENTS (ATTACH SEPARATE SHEET IF MORE SPACE IS NEEDED)

CERTIFICATION

I do hereby certify that I am duly elected, appointed and/or authorized by the Grantee named above and that the information and answers provided herein are true and accurate to the best of my personal knowledge, information and belief.

Kim Peterson
Please print

Kim Peterson
Grantee Authorized Signature

10/9/21
Date

Bruce Bourge
Please print

Bruce Bourge
Witness Signature

10/9/21
Date

Send completed report to:

POST COMPLETION GRANT INSPECTION REPORTS
GRANTS MANAGEMENT
MICHIGAN DEPARTMENT OF NATURAL RESOURCES
PO BOX 30425
LANSING MI 48909-7925





**APPENDIX L:
POST COMPLETION SELF-INSPECTION REPORT**

Michigan Department of Natural Resources - Grants Management

PUBLIC OUTDOOR RECREATION GRANT

POST-COMPLETION SELF-CERTIFICATION REPORT

This information required under authority of Part 19, PA 451 of 1994, as amended;
the Land and Water Conservation Fund Act of 1965, 78 Stat. 897 (1964); and Part 715, of PA 451 of 1994, as amended.

GRANT TYPE: (Please select one) MICHIGAN NATURAL RESOURCES TRUST FUND CLEAN MICHIGAN INITIATIVE LAND AND WATER CONSERVATION FUN RECREATION PASSPORT BOND FUND

GRANTEE: City of Escanaba

PROJECT NUMBER: BF89-555 **PROJECT TYPE:** Development

PROJECT TITLE: Ludington Park

PROJECT SCOPE: Replace electric and potable water systems

TO BE COMPLETED BY LOCAL GOVERNMENT AGENCY (GRANTEE)		
Name of Agency (Grantee)	Contact Person	Title
<u>City of Escanaba</u>	<u>Kim Peterson</u>	<u>Recreation Dir.</u>
Address	Telephone	
<u>410 Ludington Street</u>	<u>906-186-4141</u>	
City, State, ZIP	Email	
<u>Escanaba MI 49829</u>	<u>kpeterson@escanaba.org</u>	
SITE DEVELOPMENT		
Any change(s) in the facility type, site layout, or recreation activities provided? If yes, please describe change(s).		<input type="checkbox"/> Yes <input checked="" type="checkbox"/> No
Has any portion of the project site been converted to a use other than outdoor recreation? If yes, please describe what portion and describe use. (This would include cell towers and any non-recreation buildings.)		<input type="checkbox"/> Yes <input checked="" type="checkbox"/> No
Are any of the facilities obsolete? If yes, please explain.		<input type="checkbox"/> Yes <input checked="" type="checkbox"/> No
SITE QUALITY		
Is there a park entry sign which identifies the property or facility as a public recreation area? If yes, please provide a photograph of the sign. If no, please explain.		<input checked="" type="checkbox"/> Yes <input type="checkbox"/> No
Are the facilities and the site being properly maintained? If no, please explain.		<input checked="" type="checkbox"/> Yes <input type="checkbox"/> No

Is vandalism a problem at this site? If yes, explain the measures being taken to prevent or minimize vandalism. Yes No
 Currently looking at installing cameras and having additional lighting installed.

Is maintenance scheduled on a regular basis? If yes, give schedule. If no, please explain. Yes No
 General Fund - Staffing on site Monday to Friday.

GENERAL

Is a Program Recognition plaque permanently displayed at the site? If yes, please provide a photograph. (Not required for Bond Fund Grants) Yes No N/A

Is any segment of the general public restricted from using the site or facilities? (i.e. resident only, league only, boaters only, etc.) If yes, please explain. Yes No

Is a fee charged for use of the site or facilities? If yes, please provide fee structure. Yes No

What are the hours and seasons for availability of the site?
 7:00 a.m. to 11:00 p.m. Daily

COMMENTS (ATTACH SEPARATE SHEET IF MORE SPACE IS NEEDED)

CERTIFICATION

I do hereby certify that I am duly elected, appointed and/or authorized by the Grantee named above and that the information and answers provided herein are true and accurate to the best of my personal knowledge, information and belief.

Kim Petersen _____ 10/7/21
 Please print Grantee Authorized Signature Date

Brooks Baugie _____ 10/7/21
 Please print Witness Signature Date

Send completed report to: **POST COMPLETION GRANT INSPECTION REPORTS
 GRANTS MANAGEMENT
 MICHIGAN DEPARTMENT OF NATURAL RESOURCES
 PO BOX 30425
 LANSING MI 48909-7925**

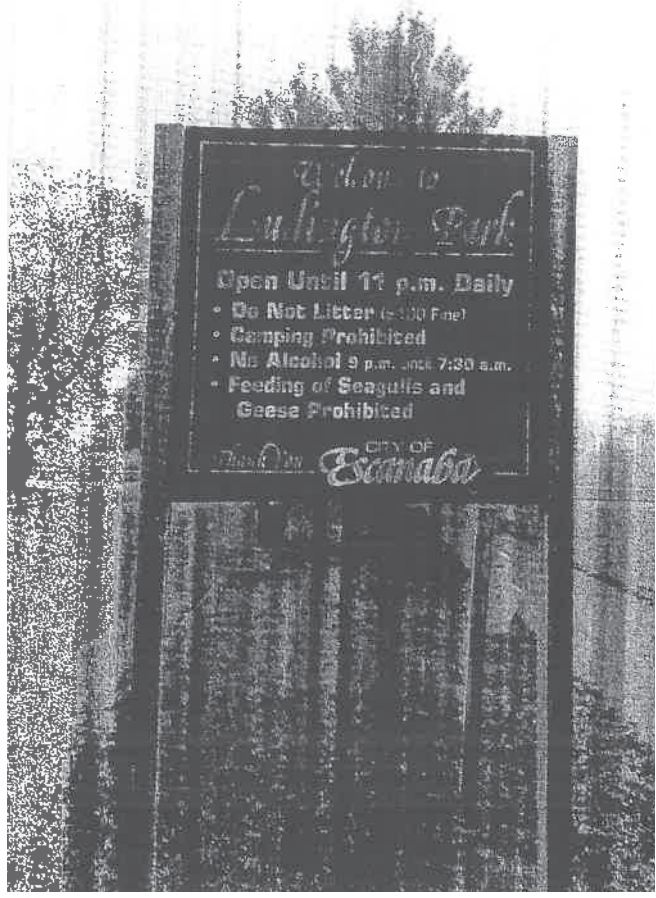



**APPENDIX L:
POST COMPLETION SELF-INSPECTION REPORT**

Michigan Department of Natural Resources - Grants Management
PUBLIC OUTDOOR RECREATION GRANT
POST-COMPLETION SELF-CERTIFICATION REPORT

This information required under authority of Part 19, PA 451 of 1994, as amended;
the Land and Water Conservation Fund Act of 1965, 78 Stat. 897 (1964); and Part 715, of PA 451 of 1994, as amended.

GRANT TYPE:
(Please select one) MICHIGAN NATURAL RESOURCES TRUST FUND CLEAN MICHIGAN INITIATIVE
 LAND AND WATER CONSERVATION FUN RECREATION PASSPORT BOND FUND

GRANTEE: City of Escanaba

PROJECT NUMBER: 26-01481 **PROJECT TYPE:** Development

PROJECT TITLE: Escanaba Municipal Beach

PROJECT SCOPE: Development of concrete rubble and beach fill.

To Be Completed By Local Government Agency (Grantee)		
Name of Agency (Grantee) <u>City of Escanaba</u>	Contact Person <u>Kim Peterson</u>	Title <u>Recreation Dir.</u>
Address <u>410 Ludington Street</u>	Telephone <u>906-736-4141</u>	
City, State, ZIP <u>Escanaba MI 49829</u>	Email <u>kpeterson@escanaba.org</u>	
SITE DEVELOPMENT		
Any change(s) in the facility type, site layout, or recreation activities provided? If yes, please describe change(s).		<input type="checkbox"/> Yes <input checked="" type="checkbox"/> No
Has any portion of the project site been converted to a use other than outdoor recreation? If yes, please describe what portion and describe use. (This would include cell towers and any non-recreation buildings.)		<input type="checkbox"/> Yes <input checked="" type="checkbox"/> No
Are any of the facilities obsolete? If yes, please explain.		<input type="checkbox"/> Yes <input checked="" type="checkbox"/> No
SITE QUALITY		
Is there a park entry sign which identifies the property or facility as a public recreation area? If yes, please provide a photograph of the sign. If no, please explain.		<input checked="" type="checkbox"/> Yes <input type="checkbox"/> No
Are the facilities and the site being properly maintained? If no, please explain.		<input checked="" type="checkbox"/> Yes <input type="checkbox"/> No

Is vandalism a problem at this site? If yes, explain the measures being taken to prevent or minimize vandalism. Yes No

Is maintenance scheduled on a regular basis? If yes, give schedule. If no, please explain. Yes No
*General Fund, Staffed daily during season
 Checked monthly after winds.*

GENERAL

Is a Program Recognition plaque permanently displayed at the site? If yes, please provide a photograph. (Not required for Bond Fund Grants) Yes No N/A

Is any segment of the general public restricted from using the site or facilities? (i.e. resident only, league only, boaters only, etc.) If yes, please explain. Yes No

Is a fee charged for use of the site or facilities? If yes, please provide fee structure. Yes No

What are the hours and seasons for availability of the site? *Lifeguard daily 12:00pm - 7:00pm
 Summer, Park open 7:00am - 11:00pm.*

COMMENTS (ATTACH SEPARATE SHEET IF MORE SPACE IS NEEDED)

(Empty space for comments)

CERTIFICATION

I do hereby certify that I am duly elected, appointed and/or authorized by the Grantee named above and that the information and answers provided herein are true and accurate to the best of my personal knowledge, information and belief.

Jim Peterson *W. Peterson* *10/7/21*
 Please print Grantee Authorized Signature Date
Brooks Bougie *Brooks Bougie* *10/9/21*
 Please print Witness Signature Date

Send completed report to:
**POST COMPLETION GRANT INSPECTION REPORTS
 GRANTS MANAGEMENT
 MICHIGAN DEPARTMENT OF NATURAL RESOURCES
 PO BOX 30425
 LANSING MI 48909-7925**

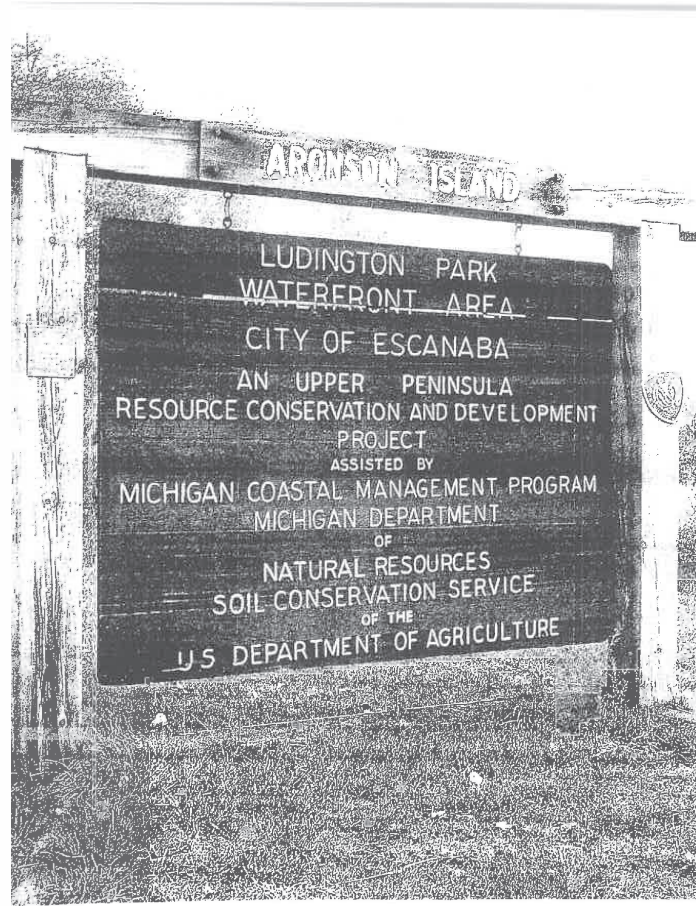

**APPENDIX L:
POST COMPLETION SELF-INSPECTION REPORT**



Michigan Department of Natural Resources - Grants Management
**PUBLIC OUTDOOR RECREATION GRANT
POST-COMPLETION SELF-CERTIFICATION REPORT**

*This information required under authority of Part 19, PA 451 of 1994, as amended;
the Land and Water Conservation Fund Act of 1965, 78 Stat. 857 (1964); and Part 715, of PA 451 of 1994, as amended.*

GRANT TYPE:
(Please select one) MICHIGAN NATURAL RESOURCES TRUST FUND CLEAN MICHIGAN INITIATIVE
 LAND AND WATER CONSERVATION FUN RECREATION PASSPORT BOND FUND

GRANTEE: City of Escanaba

PROJECT NUMBER: 26-01215 **PROJECT TYPE:** Development

PROJECT TITLE: Sand Island Boat Launch

PROJECT SCOPE: Launch ramp, toilets and parking area

TO BE COMPLETED BY LOCAL GOVERNMENT AGENCY (GRANTEE)	
Name of Agency (Grantee) <u>City of Escanaba</u>	Contact Person <u>Kim Peterson</u> Title <u>Recreation Dir.</u>
Address <u>410 Ludington Street</u>	Telephone <u>906-136-4141</u>
City, State, ZIP <u>Escanaba MI 49829</u>	Email <u>kpeterson@escanaba.org</u>

SITE DEVELOPMENT
Any change(s) in the facility type, site layout, or recreation activities provided?
If yes, please describe change(s). Yes No

Has any portion of the project site been converted to a use other than outdoor recreation? If yes, please describe what portion and describe use. (This would include cell towers and any non-recreation buildings.) Yes No

Are any of the facilities obsolete? If yes, please explain. Yes No

SITE QUALITY
Is there a park entry sign which identifies the property or facility as a public recreation area?
If yes, please provide a photograph of the sign. If no, please explain. Yes No

Are the facilities and the site being properly maintained? If no, please explain. Yes No

Is vandalism a problem at this site? If yes, explain the measures being taken to prevent or minimize vandalism. Yes No

Is maintenance scheduled on a regular basis? If yes, give schedule. If no, please explain. Yes No

General Fund. Staff on site during season did
worked up during off season.

GENERAL

Is a Program Recognition plaque permanently displayed at the site? If yes, please provide a photograph. (Not required for Bond Fund Grants) Yes No N/A

Is any segment of the general public restricted from using the site or facilities? (i.e. resident only, league only, boaters only, etc.) If yes, please explain. Yes No

Is a fee charged for use of the site or facilities? If yes, please provide fee structure. Yes No

\$4.00 Daily launch fee. \$45 yearly
launch fee.

What are the hours and seasons for availability of the site?

7:00 a.m. - 11:00 p.m. Daily May - November

COMMENTS (ATTACH SEPARATE SHEET IF MORE SPACE IS NEEDED)

CERTIFICATION

I do hereby certify that I am duly elected, appointed and/or authorized by the Grantee named above and that the information and answers provided herein are true and accurate to the best of my personal knowledge, information and belief.

Kim Peterson Please print Kim Peterson Grantee Authorized Signature 10/7/21 Date

Bruce Booge Please print Bruce Booge Witness Signature 10/7/21 Date

Send completed report to:

POST COMPLETION GRANT INSPECTION REPORTS
GRANTS MANAGEMENT
MICHIGAN DEPARTMENT OF NATURAL RESOURCES
PO BOX 30425
LANSING MI 48909-7925

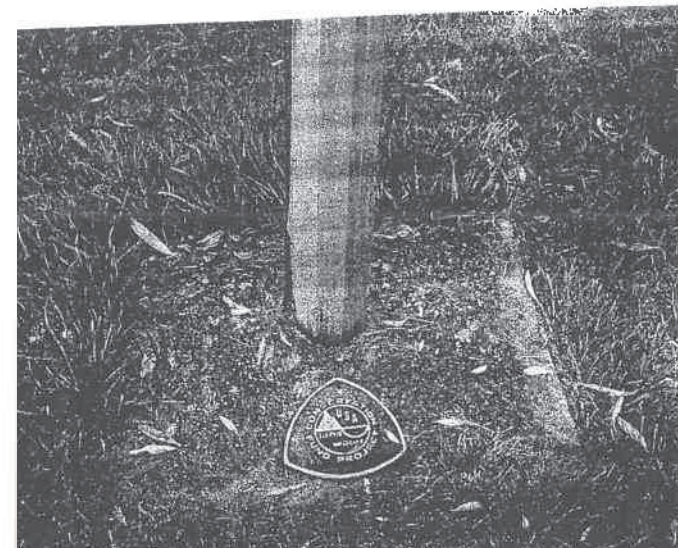

**APPENDIX L:
POST COMPLETION SELF-INSPECTION REPORT**



Michigan Department of Natural Resources - Grants Management
PUBLIC OUTDOOR RECREATION GRANT

POST-COMPLETION SELF-CERTIFICATION REPORT

*This information required under authority of Part 19, PA 451 of 1994, as amended;
the Land and Water Conservation Fund Act of 1965, 78 Stat. 897 (1964); and Part 715, of PA 451 of 1994, as amended.*

GRANT TYPE:
(Please select one)

MICHIGAN NATURAL RESOURCES TRUST FUND CLEAN MICHIGAN INITIATIVE
 LAND AND WATER CONSERVATION FUN RECREATION PASSPORT BOND FUND

GRANTEE: City of Escanaba

PROJECT NUMBER: BF91-329 **PROJECT TYPE:** Development

PROJECT TITLE: Ludington Park Playground

PROJECT SCOPE: Renovate & replace playground equipment

TO BE COMPLETED BY LOCAL GOVERNMENT AGENCY (GRANTEE)

Name of Agency (Grantee)	Contact Person	Title
<u>City of Escanaba</u>	<u>Kim Peterson</u>	<u>Recreation Dir.</u>
Address	Telephone	
<u>410 Ludington Street</u>	<u>906-186-4141</u>	
City, State, ZIP	Email	
<u>Escanaba MI 49829</u>	<u>kpeterson@escanaba.org</u>	

SITE DEVELOPMENT

Any change(s) in the facility type, site layout, or recreation activities provided? If yes, please describe change(s). Yes No

Has any portion of the project site been converted to a use other than outdoor recreation? If yes, please describe what portion and describe use. (This would include cell towers and any non-recreation buildings.) Yes No

Are any of the facilities obsolete? If yes, please explain. Yes No

SITE QUALITY

Is there a park entry sign which identifies the property or facility as a public recreation area? If yes, please provide a photograph of the sign. If no, please explain. Yes No

Are the facilities and the site being properly maintained? If no, please explain. Yes No

Is vandalism a problem at this site? If yes, explain the measures being taken to prevent or minimize vandalism. Yes No

Is maintenance scheduled on a regular basis? If yes, give schedule. If no, please explain. Yes No
General Fund. Staff on site Monday to Friday.

GENERAL

Is a Program Recognition plaque permanently displayed at the site? If yes, please provide a photograph. (Not required for Bond Fund Grants) Yes No N/A

Is any segment of the general public restricted from using the site or facilities? (i.e. resident only, league only, boaters only, etc.) If yes, please explain. Yes No

Is a fee charged for use of the site or facilities? If yes, please provide fee structure. Yes No

What are the hours and seasons for availability of the site?
Daily 7:00 a.m. - 11:00 p.m.

COMMENTS (ATTACH SEPARATE SHEET IF MORE SPACE IS NEEDED)

CERTIFICATION

I do hereby certify that I am duly elected, appointed and/or authorized by the Grantee named above and that the information and answers provided herein are true and accurate to the best of my personal knowledge, information and belief.

<i>Kim Peterson</i> Please print	<i>[Signature]</i> Grantee Authorized Signature	<i>10/17/21</i> Date
<i>Bruce Bougie</i> Please print	<i>[Signature]</i> Witness Signature	<i>10/17/21</i> Date

Send completed report to: **POST COMPLETION GRANT INSPECTION REPORTS
 GRANTS MANAGEMENT
 MICHIGAN DEPARTMENT OF NATURAL RESOURCES
 PO BOX 30425
 LANSING MI 48909-7925**





**APPENDIX L:
POST COMPLETION SELF-INSPECTION REPORT**

Michigan Department of Natural Resources - Grants Management
PUBLIC OUTDOOR RECREATION GRANT
POST-COMPLETION SELF-CERTIFICATION REPORT

This information required under authority of Part 19, PA 451 of 1994, as amended:
the Land and Water Conservation Fund Act of 1965, 78 Stat. 897 (1964); and Part 715, of PA 451 of 1994, as amended.

GRANT TYPE: (Please select one)
 MICHIGAN NATURAL RESOURCES TRUST FUND CLEAN MICHIGAN INITIATIVE
 LAND AND WATER CONSERVATION FUN RECREATION PASSPORT BOND FUND

GRANTEE: City of Escanaba

PROJECT NUMBER: 26-01328 **PROJECT TYPE:** Development

PROJECT TITLE: Ludington Park Restrooms

PROJECT SCOPE: Toilet building, site work and utilities.

TO BE COMPLETED BY LOCAL GOVERNMENT AGENCY (GRANTEE)	
Name of Agency (Grantee) <u>City of Escanaba</u>	Contact Person <u>Kim Peterson</u> Title <u>Recreation Dir.</u>
Address <u>410 Ludington Street</u>	Telephone <u>906-786-4141</u>
City, State, ZIP <u>Escanaba MI 49829</u>	Email <u>kpeterson@escanaba.org</u>
SITE DEVELOPMENT	
Any change(s) in the facility type, site layout, or recreation activities provided? If yes, please describe change(s). <input type="checkbox"/> Yes <input checked="" type="checkbox"/> No	
Has any portion of the project site been converted to a use other than outdoor recreation? If yes, please describe what portion and describe use. (This would include cell towers and any non-recreation buildings.) <input type="checkbox"/> Yes <input checked="" type="checkbox"/> No	
Are any of the facilities obsolete? If yes, please explain. <input type="checkbox"/> Yes <input checked="" type="checkbox"/> No	
SITE QUALITY	
Is there a park entry sign which identifies the property or facility as a public recreation area? If yes, please provide a photograph of the sign. If no, please explain. <input checked="" type="checkbox"/> Yes <input type="checkbox"/> No	
Are the facilities and the site being properly maintained? If no, please explain. <input checked="" type="checkbox"/> Yes <input type="checkbox"/> No	

Is vandalism a problem at this site? If yes, explain the measures being taken to prevent or minimize vandalism. Yes No

Is maintenance scheduled on a regular basis? If yes, give schedule. If no, please explain. Yes No
General Fund Staff on site Monday to Friday

GENERAL

Is a Program Recognition plaque permanently displayed at the site? If yes, please provide a photograph. (Not required for Bond Fund Grants) Yes No N/A

Is any segment of the general public restricted from using the site or facilities? (i.e. resident only, league only, boaters only, etc.) If yes, please explain. Yes No

Is a fee charged for use of the site or facilities? If yes, please provide fee structure. Yes No

What are the hours and seasons for availability of the site?
7:00 a.m. - 11:00 p.m. Daily

COMMENTS (ATTACH SEPARATE SHEET IF MORE SPACE IS NEEDED)

CERTIFICATION

I do hereby certify that I am duly elected, appointed and/or authorized by the Grantee named above and that the information and answers provided herein are true and accurate to the best of my personal knowledge, information and belief.

<u>Kim Peterova</u> Please print	<u>[Signature]</u> Grantee Authorized Signature	<u>10/7/21</u> Date
<u>Brooks Souge</u> Please print	<u>[Signature]</u> Witness Signature	<u>10/7/21</u> Date

Send completed report to: **POST COMPLETION GRANT INSPECTION REPORTS
 GRANTS MANAGEMENT
 MICHIGAN DEPARTMENT OF NATURAL RESOURCES
 PO BOX 30425
 LANSING MI 48909-7925**





**APPENDIX L:
POST COMPLETION SELF-INSPECTION REPORT**

Michigan Department of Natural Resources - Grants Management
PUBLIC OUTDOOR RECREATION GRANT

POST-COMPLETION SELF-CERTIFICATION REPORT

*This information required under authority of Part 19, PA 451 of 1994, as amended;
the Land and Water Conservation Fund Act of 1965, 78 Stat. 897 (1964); and Part 715, of PA 451 of 1994, as amended.*

GRANT TYPE:
(Please select one) MICHIGAN NATURAL RESOURCES TRUST FUND CLEAN MICHIGAN INITIATIVE
 LAND AND WATER CONSERVATION FUND RECREATION PASSPORT BOND FUND

GRANTEE: City of Escanaba

PROJECT NUMBER: RPL3-481 **PROJECT TYPE:** Development

PROJECT TITLE: Ludington Park Tennis Courts Renovation

PROJECT SCOPE: ADA incorporation and surface renovation to courts

TO BE COMPLETED BY LOCAL GOVERNMENT AGENCY (GRANTEE)		
Name of Agency (Grantee)	Contact Person	Title
<u>City of Escanaba</u>	<u>Kim Peterson</u>	<u>Recreation Dir.</u>
Address	Telephone	
<u>410 Ludington Street</u>	<u>906-786-4141</u>	
City, State, ZIP	Email	
<u>Escanaba MI 49829</u>	<u>kpeterson@escanaba.org</u>	
SITE DEVELOPMENT		
Any change(s) in the facility type, site layout, or recreation activities provided? If yes, please describe change(s).		<input type="checkbox"/> Yes <input checked="" type="checkbox"/> No
Has any portion of the project site been converted to a use other than outdoor recreation? If yes, please describe what portion and describe use. (This would include cell towers and any non-recreation buildings.)		<input type="checkbox"/> Yes <input checked="" type="checkbox"/> No
Are any of the facilities obsolete? If yes, please explain.		<input type="checkbox"/> Yes <input checked="" type="checkbox"/> No
SITE QUALITY		
Is there a park entry sign which identifies the property or facility as a public recreation area? If yes, please provide a photograph of the sign. If no, please explain.		<input checked="" type="checkbox"/> Yes <input type="checkbox"/> No
Are the facilities and the site being properly maintained? If no, please explain.		<input checked="" type="checkbox"/> Yes <input type="checkbox"/> No

is vandalism a problem at this site? If yes, explain the measures being taken to prevent or minimize vandalism. Yes No
Currently looking at installing cameras and having additional lights installed.

Is maintenance scheduled on a regular basis? If yes, give schedule. If no, please explain. Yes No
Part of General Fund. Staff on site Monday to Friday.

GENERAL

Is a Program Recognition plaque permanently displayed at the site? If yes, please provide a photograph. (Not required for Bond Fund Grants) Yes No N/A

Is any segment of the general public restricted from using the site or facilities? (i.e. resident only, league only, boaters only, etc.) If yes, please explain. Yes No

Is a fee charged for use of the site or facilities? If yes, please provide fee structure. Yes No

What are the hours and seasons for availability of the site?
Daily 7:00 a.m. to 11:00 p.m.

COMMENTS (ATTACH SEPARATE SHEET IF MORE SPACE IS NEEDED)

CERTIFICATION

I do hereby certify that I am duly elected, appointed and/or authorized by the Grantee named above and that the information and answers provided herein are true and accurate to the best of my personal knowledge, information and belief.

Kim Peterson
Please print _____ *Anterson* _____ *10/7/21* _____
Please print _____ Grantee Authorized Signature _____ Date

Bruce Bourje
Please print _____ *Bruce Bourje* _____ *10/7/21* _____
Please print _____ Witness Signature _____ Date

Send completed report to:
POST COMPLETION GRANT INSPECTION REPORTS
GRANTS MANAGEMENT
MICHIGAN DEPARTMENT OF NATURAL RESOURCES
PO BOX 30425
LANSING MI 48909-7925

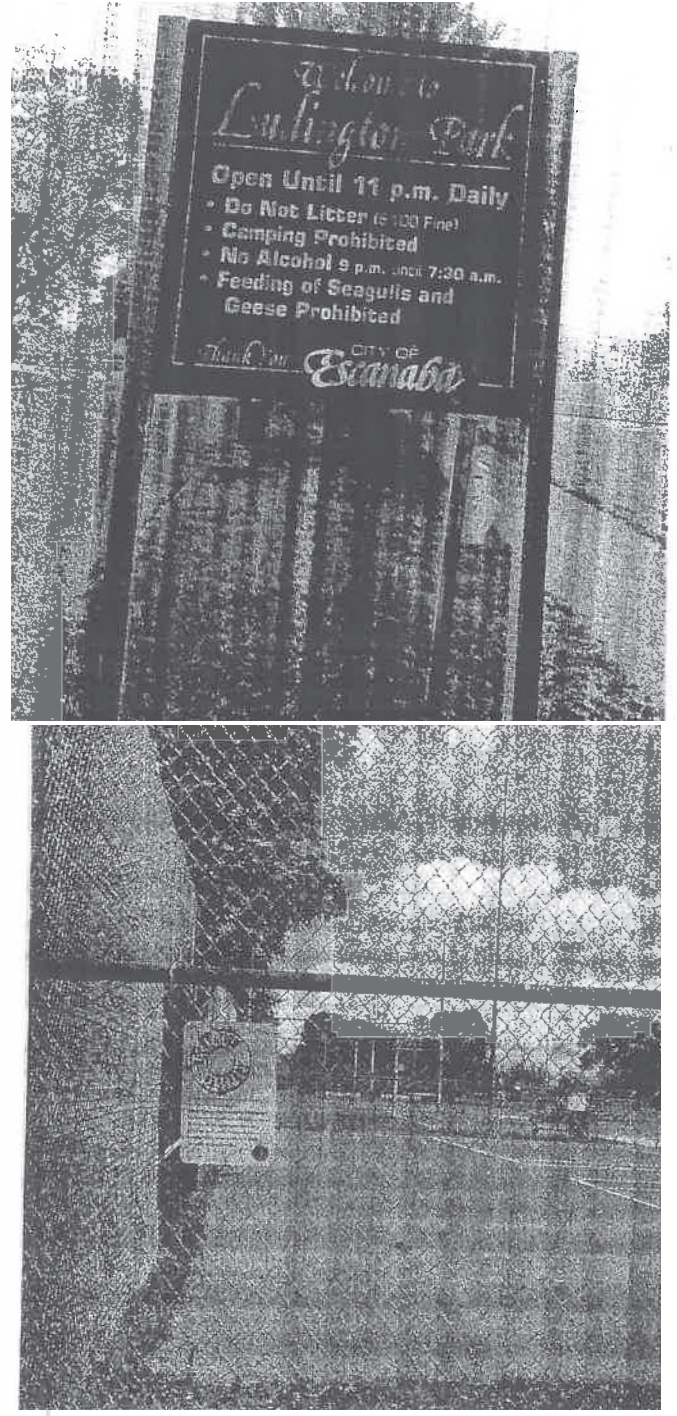

**APPENDIX L:
POST COMPLETION SELF-INSPECTION REPORT**



Michigan Department of Natural Resources - Grants Management
**PUBLIC OUTDOOR RECREATION GRANT
POST-COMPLETION SELF-CERTIFICATION REPORT**

This information required under authority of Part 19, PA 451 of 1994, as amended;
the Land and Water Conservation Fund Act of 1965, 78 Stat. 897 (1964); and Part 715, of PA 451 of 1994, as amended.

GRANT TYPE: (Please select one)
 MICHIGAN NATURAL RESOURCES TRUST FUND CLEAN MICHIGAN INITIATIVE
 LAND AND WATER CONSERVATION FUN RECREATION PASSPORT BOND FUND

GRANTEE: City of Escanaba

PROJECT NUMBER: TF99-384 PROJECT TYPE: Acquisition

PROJECT TITLE: Escanaba Riverfront Property Acquisition

PROJECT SCOPE: Acquire 12.83 acres of land.

TO BE COMPLETED BY LOCAL GOVERNMENT AGENCY (GRANTEE)	
Name of Agency (Grantee)	Contact Person Title
<u>City of Escanaba</u>	<u>Kim Peterson Recreation Dir.</u>
Address <u>510 Ludington Street</u>	Telephone <u>906-126-4141</u>
City, State, ZIP <u>Escanaba MI 49829</u>	Email <u>kpeterson@escanaba.org</u>

SITE DEVELOPMENT
 Any change(s) in the facility type, site layout, or recreation activities provided? If yes, please describe change(s). Yes No

Has any portion of the project site been converted to a use other than outdoor recreation? If yes, please describe what portion and describe use. (This would include cell towers and any non-recreation buildings.) Yes No

Are any of the facilities obsolete? If yes, please explain. Yes No

SITE QUALITY
 Is there a park entry sign which identifies the property or facility as a public recreation area? If yes, please provide a photograph of the sign. If no, please explain. Yes No
 Are the facilities and the site being properly maintained? If no, please explain. Yes No

Is vandalism a problem at this site? If yes, explain the measures being taken to prevent or minimize vandalism. Yes No

Is maintenance scheduled on a regular basis? If yes, give schedule. If no, please explain. Yes No
General Fund & Marling. Checked daily for launch fees and locked during off season.

GENERAL
Is a Program Recognition plaque permanently displayed at the site? If yes, please provide a photograph. (Not required for Bond Fund Grants) Yes No N/A

Is any segment of the general public restricted from using the site or facilities? (i.e. resident only, league only, boaters only, etc.) If yes, please explain. Yes No

Is a fee charged for use of the site or facilities? If yes, please provide fee structure. Yes No
\$4.00 Daily launch fee. \$45.00 yearly launch fee.

What are the hours and seasons for availability of the site?
24 hours Seasonal April/May - November.

COMMENTS (ATTACH SEPARATE SHEET IF MORE SPACE IS NEEDED)

CERTIFICATION
I do hereby certify that I am duly elected, appointed and/or authorized by the Grantee named above and that the information and answers provided herein are true and accurate to the best of my personal knowledge, information and belief.
Kim Peterson [Signature] 10/7/21
Please print Grantee Authorized Signature Date
Brooks Bougie [Signature] 10/7/21
Please print Witness Signature Date

Send completed report to:
**POST COMPLETION GRANT INSPECTION REPORTS
GRANTS MANAGEMENT
MICHIGAN DEPARTMENT OF NATURAL RESOURCES
PO BOX 30425
LANSING MI 48909-7925**

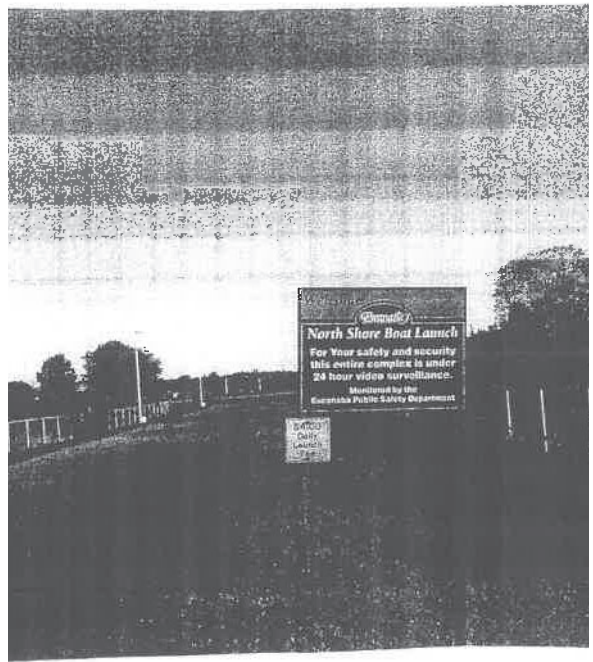

**APPENDIX L:
POST COMPLETION SELF-INSPECTION REPORT**



Michigan Department of Natural Resources - Grants Management
**PUBLIC OUTDOOR RECREATION GRANT
POST-COMPLETION SELF-CERTIFICATION REPORT**

This information required under authority of Part 19, PA 451 of 1994, as amended;
the Land and Water Conservation Fund Act of 1965, 78 Stat. 897 (1964); and Part 715, of PA 451 of 1994, as amended.

GRANT TYPE:
(Please select one)

MICHIGAN NATURAL RESOURCES TRUST FUND CLEAN MICHIGAN INITIATIVE
 LAND AND WATER CONSERVATION FUN RECREATION PASSPORT BOND FUND

GRANTEE: City of Escanaba

PROJECT NUMBER: RP16-0133 **PROJECT TYPE:** Development

PROJECT TITLE: Escanaba Market place & Park Structure

PROJECT SCOPE: New play ground and access pathways

TO BE COMPLETED BY LOCAL GOVERNMENT AGENCY (GRANTEE)	
Name of Agency (Grantee) <u>City of Escanaba</u>	Contact Person <u>Kim Peterson</u> Title <u>Recreation Dir.</u>
Address <u>410 Ludington street</u>	Telephone <u>906-186-4141</u>
City, State, ZIP <u>Escanaba MI 49829</u>	Email <u>kpeterson@escanaba.org</u>

SITE DEVELOPMENT
Any change(s) in the facility type, site layout, or recreation activities provided? If yes, please describe change(s). Yes No

Has any portion of the project site been converted to a use other than outdoor recreation? If yes, please describe what portion and describe use. (This would include cell towers and any non-recreation buildings.) Yes No

Are any of the facilities obsolete? If yes, please explain. Yes No

SITE QUALITY
Is there a park entry sign which identifies the property or facility as a public recreation area? If yes, please provide a photograph of the sign. If no, please explain. Yes No

Are the facilities and the site being properly maintained? If no, please explain. Yes No

Is vandalism a problem at this site? If yes, explain the measures being taken to prevent or minimize vandalism. Yes No
 Cameras were installed.

Is maintenance scheduled on a regular basis? If yes, give schedule. If no, please explain. Yes No
 DDA staff and security checks daily

GENERAL

Is a Program Recognition plaque permanently displayed at the site? If yes, please provide a photograph. (Not required for Bond Fund Grants) Yes No N/A

Is any segment of the general public restricted from using the site or facilities? (i.e. resident only, league only, boaters only, etc.) If yes, please explain. Yes No

Is a fee charged for use of the site or facilities? If yes, please provide fee structure. Yes No

What are the hours and seasons for availability of the site?
 24/7 Daily

COMMENTS (ATTACH SEPARATE SHEET IF MORE SPACE IS NEEDED)

CERTIFICATION

I do hereby certify that I am duly elected, appointed and/or authorized by the Grantee named above and that the information and answers provided herein are true and accurate to the best of my personal knowledge, information and belief.

Kim Peterson Please print Kim Peterson Grantor/Authorized Signature [Signature] Date 10/7/21

Brooks Bougie Please print Brooks Bougie Witness Signature [Signature] Date 10/7/21

Send completed report to: POST COMPLETION GRANT INSPECTION REPORTS
 GRANTS MANAGEMENT
 MICHIGAN DEPARTMENT OF NATURAL RESOURCES
 PO BOX 30425
 LANSING MI 48909-7925



Appendix C

GUIDELINES FOR DESIGNING ADA COMPLIANT AND UNIVERSALLY ACCESSIBLE PARKS

MICHIGAN DNR GUIDELINES | [HTTPS://WWW.MICHIGAN.GOV/DOCUMENTS/DNR/UA-ADA_GUIDELINES_380528_7.PDF](https://www.michigan.gov/documents/dnr/ua-ada_guidelines_380528_7.pdf)

ACCESSIBLE TRAILS

- WALKWAYS WITHIN A SITE - minimum 6 foot width and slopes under 2%
- MULTI-USE TRAIL - 8 feet, with slopes under 2%, wider width so two people can walk side by side or people can pass
- REGIONAL TRAIL SYSTEM - at least 10 feet wide, with 1-foot buffers on either side, with slopes under 2%
- SURFACE TREATMENT - unitary surface (ex. concrete, boardwalk or asphalt, crushed aggregate/screenings that have been “stabilized” or natural soils enhanced with soil stabilizers)
- TRANSITIONS - plates between trail and pedestrian bridges, decks, etc.
- INTERSECTIONS - contrasting color treatment and textured surface treatments such as brushed concrete at intersections or interpretive stations to cue people who have vision impairments that there is something to pay attention to at that spot
- close to level cross slopes (side to side) and very gentle running slopes, no steep sections, larger (greater than 60”X60”) level areas at all turns and intersections
- thoughtfully laid out on the site to maximize the experience with minimal difficulty
- AMENITIES - All should be accessible including: benches, restrooms (port-a-johns), drinking fountains, etc.

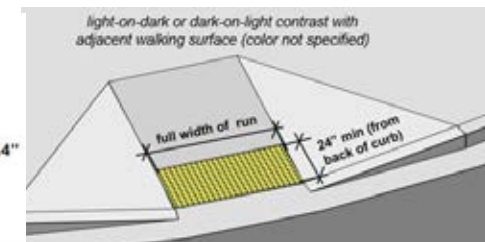
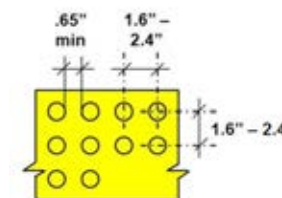
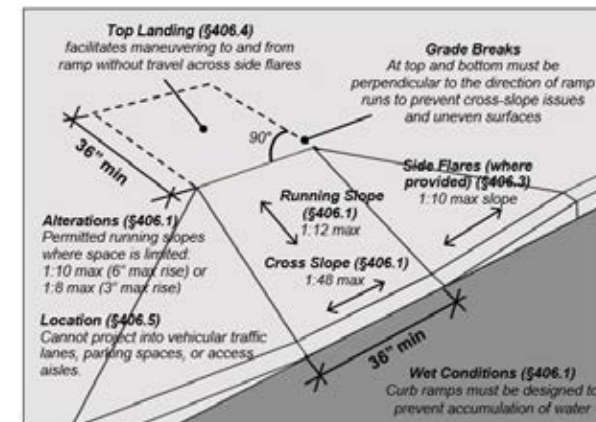
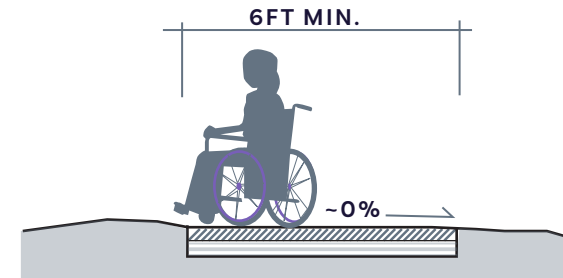

Universal Access

GUIDELINES FOR DESIGNING ADA COMPLIANT AND UNIVERSALLY ACCESSIBLE PARKS

MICHIGAN DNR GUIDELINES | [HTTPS://WWW.MICHIGAN.GOV/DOCUMENTS/DNR/UA-ADA_GUIDELINES_380528_7.PDF](https://www.michigan.gov/documents/dnr/ua-ada_guidelines_380528_7.pdf)

- BEACH**
- routes over the beach and into the water, can be portable/ temporary matting if it needs to be taken in and out for beach cleaning/dragging or in the off season
 - wide enough for side by side walking/passing
 - at beach route end have an accessible area at the waters edge large enough to park multiple chairs while the owners are in the water
 - with a transfer system at the waters edge so people can get down to the ground level and into the water.



TRANSFER STATION

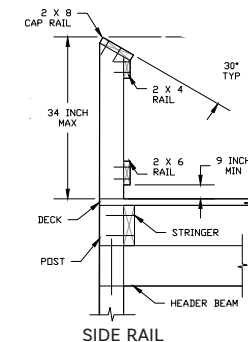

FISHING DOCK + VIEWING DECK

- more than 25% of the rails are lowered in various locations or no rails at all with only an edge treatment to prevent roll off
- sitting benches (all with backs and arm rests) scattered about so anglers can choose to sit or stand to fish
- tackle box stands next to one bench end (not both) leaving one end clear space for sitting side by side with someone in a wheelchair
- a variety of fish landing cutaways strategically placed
- variety of accessible opportunities—over-water fishing, shore fishing, in-water fishing, etc.
- transition plates between access route and deck/pier

CAMPING

- accessible surface on all sites, including rustic sites
- larger spaces to accommodate side lifts on campers and vehicles
- accessible tables, grills (15 " minimum, 34 " maximum height), and fire rings on all sites
- centrally located restrooms on easy routes from each site



Universal Access

GUIDELINES FOR DESIGNING ADA COMPLIANT AND UNIVERSALLY ACCESSIBLE PARKS

MICHIGAN DNR GUIDELINES | [HTTPS://WWW.MICHIGAN.GOV/DOCUMENTS/DNR/UA-ADA_GUIDELINES_380528_7.PDF](https://www.michigan.gov/documents/dnr/ua-ada_guidelines_380528_7.pdf)

CABINS + YURTS

- larger clear space and maneuvering spaces in between all furnishings, including when all are in use (beds, tables/chairs with people seated at the table, shelves within lowered reach ranges, lowered wall hooks, etc.)
- larger clear space thoughtfully located for typical portable items such as coolers, luggage, equipment/food bins/tubs, etc.



CANOE KAYAK OR BOAT LAUNCH

- wider route so someone can hand wheel boat on dolly to launch pulling boat next to them if they are in a wheelchair or two person carry down
- accessible surface to waters edge and into water at launch
- more gentle slopes for easier entry and exit when hand wheeling a boat
- some type of “rack” to stabilize boat at a transferable height then some type of mechanism/roller system to move, while seated in the boat, into the water
- some means of transfer assistance such as overhead bars
- some type of wench system to help pull boat out of water back into the rack to exit/transfer out.
- if there is a dock provide a transfer system on the dock so a person can be seated on the dock to transfer over to a boat in the water that is in some type of a stabilizer rack
- adaptive kayaks available for use
- shore station with a platform (instead of “V” rack) with a transfer system on the deck of the shore station, located next to a dock so someone could roll/get on the platform and lower it to the right level to transfer into a boat



Universal Access

GUIDELINES FOR DESIGNING ADA COMPLIANT AND UNIVERSALLY ACCESSIBLE PARKS

MICHIGAN DNR GUIDELINES | [HTTPS://WWW.MICHIGAN.GOV/DOCUMENTS/DNR/UA-ADA_GUIDELINES_380528_7.PDF](https://www.michigan.gov/documents/dnr/ua-ada_guidelines_380528_7.pdf)

SKIING + SLEDDING HILL

- accessible route to top (no steps), possibly using a “magic carpet” lift
- level surface for sled mounting at hill top
- if staffed, provide ATV transport or have policy that allows personal ATV use
- transfer at hill bottom to help transfer down to sled and back up into chair/walker



<https://www.movingmountainsap.org/>

SPORT COURTS + FIELDS

- routes to both sides of all fields and courts, not just end zones
- accessible seating spaces both ground level and elevated if risers/bleachers are provided
- accessible seating spaces scattered throughout all viewing areas and levels with companion seating on both sides of the space
- all lowered service windows at all concession areas
- wider gate openings into court areas (tennis, bocce, basketball) and skate parks to accommodate wider sports wheelchairs
- routes to both horseshoe pits and along both sides of the route between pits
- level routes onto bocce courts with sitting benches at both ends



MAGIC CARPET LIFT



Universal Access

GUIDELINES FOR DESIGNING ADA COMPLIANT AND UNIVERSALLY ACCESSIBLE PARKS

MICHIGAN DNR GUIDELINES | [HTTPS://WWW.MICHIGAN.GOV/DOCUMENTS/DNR/UA-ADA_GUIDELINES_380528_7.PDF](https://www.michigan.gov/documents/dnr/ua-ada_guidelines_380528_7.pdf)

- PLAYGROUNDS**
- has both ramp and transfer access to all play components
 - ramps to every “getting on spot” or “sit/stand & do it spot” of every play component
 - transfer system from the ground up to the main deck located near the exits of slides and climbers furthest from the ramp onto the structure
 - only unitary safety surface such as poured-in-place or rubber tiles NOT any loose fill materials likes shredded rubber, wood chips, engineered wood fiber, or any other non-unitary surface material
 - on deck transfer platform at the entry point of every slide
 - on deck transfer platform with one open transfer side and one side with transfer steps to every entry/exit point of every climber, so kids climbing up can get down to the deck to move to another component, as they may have left an assistive device at the ground
 - a good variety of things to manipulate that make noise or music, have high contrast/bright colors, games that two kids can play (to foster social interaction), Braille and sign language panels to teach awareness, easy to operate with just one hand with a whole fist (does not require tight/pinch/grasp/wrist twist to operate)
 - different high contrast colors for decks versus transfers so kids with low vision can perceive a change in level
 - play panels are located at heights so they can be used from a seated position or standing



Universal Access

GUIDELINES FOR DESIGNING ADA COMPLIANT AND UNIVERSALLY ACCESSIBLE PARKS

MICHIGAN DNR GUIDELINES | [HTTPS://WWW.MICHIGAN.GOV/DOCUMENTS/DNR/UA-ADA_GUIDELINES_380528_7.PDF](https://www.michigan.gov/documents/dnr/ua-ada_guidelines_380528_7.pdf)

BOARDWALKS

- (A) -6 foot minimum width so two people can walk side by side or people can pass
 - (B) -EDGE TREATMENT to prevent roll/step off
 - (C) -SIDE RAILS - more than 25% must be lowered for easy viewing in various places along the boardwalk
- INTERPRETIVE INFORMATION - in a variety of alternative formats such as auditory, large print, Braille, pictures, etc.

NATURE CENTER

- INTERPRETIVE INFORMATION - in a variety of alternative formats such as auditory, large print, Braille, pictures, etc.
- TECHNOLOGY - Creative use such as mp3 players for auditory descriptions (this gives the info. directly to the individual) closed loop assistive listening devices and closed circuit captioning of all interpretive presentations
- all displays at lowered heights for sitting or standing viewing
- all operating mechanisms that are operable with one hand and do not require tight/pinch/grasp/wrist twist to operate

PARKING

- more than minimum number of accessible spots
- each connected directly to an accessible route to the park elements and NOT into the traffic flow
- thoughtfully located nearest the activity entrance, which might require multiple lots (some near the beach, some near the playground, some near the bathhouse, etc.)

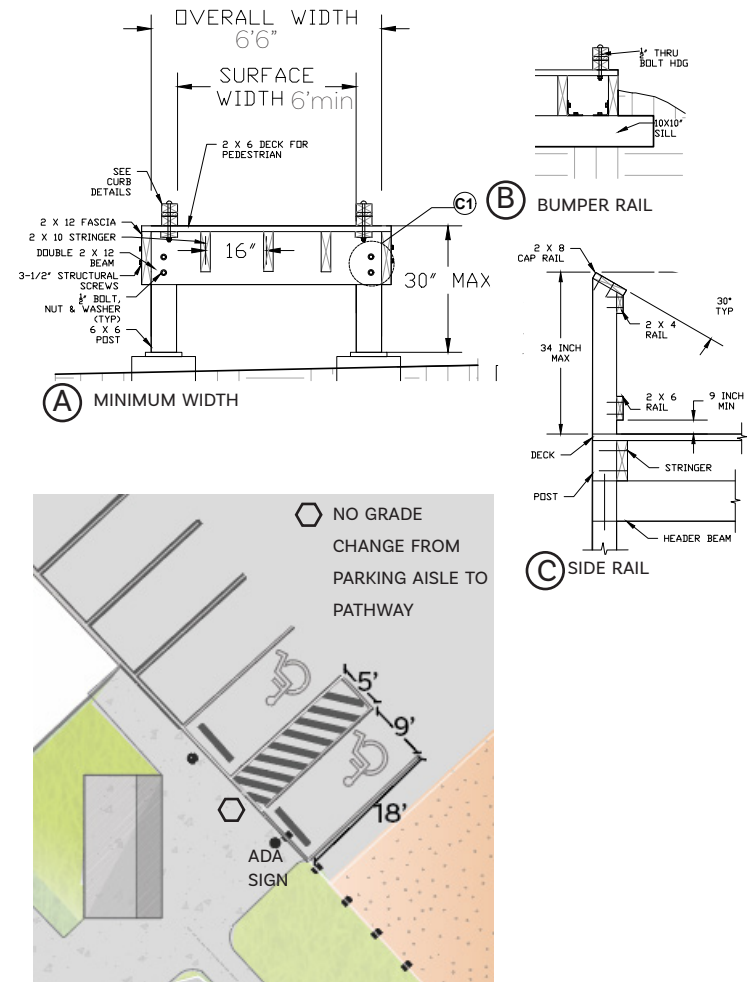

Universal Access

GUIDELINES FOR DESIGNING ADA COMPLIANT AND UNIVERSALLY ACCESSIBLE PARKS

MICHIGAN DNR GUIDELINES | [HTTPS://WWW.MICHIGAN.GOV/DOCUMENTS/DNR/UA-ADA_GUIDELINES_380528_7.PDF](https://www.michigan.gov/documents/dnr/ua-ada_guidelines_380528_7.pdf)

RESTROOMS

- more than the minimum number of accessible units
- multiple unisex/single user toilet rooms/units so opposite sex care givers can assist; also good for parents of young children of the opposite sex so kids aren't sent alone into the multi-user restroom
- thoughtfully located near areas of activity such as play areas, beaches, fishing piers, etc.
- accessible door pulls and water faucet handles
- all accessible port-a-johns, again big enough for individual use or care giver/parental assistance.

PICNIC AREAS + ELEMENTS

- all tables, grills, fire rings, water pumps, etc. accessible
- all located on accessible routes
- level routes onto pavilions with no changes of level from path to pavilion surface
- wider routes and clear space with firm surface around all elements so someone with mobility limits can easily move around the element (table, grill, etc.)
- a variety of table styles, some with clear sitting space on the side, some with extended table tops on the end
- some fixed tables to ensure they remain accessible (not moved off into a grassy or sandy area, etc.)
- clear space all around each element so people can approach and use the grill, fire ring, etc. from the front, back and either side
- grills you can lower/raise the cooking surface with one hand
- raised fire building surfaces so you can place wood without leaning too far over from a standing or seated position

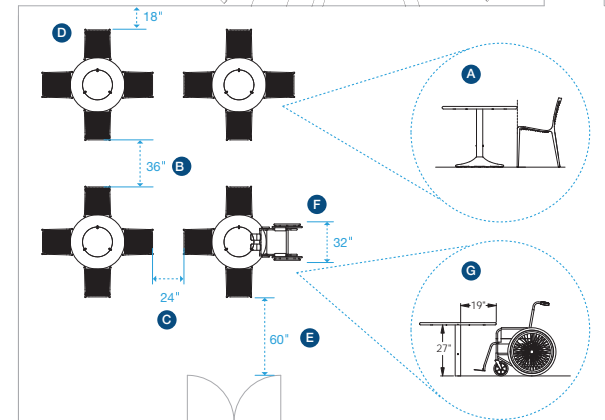
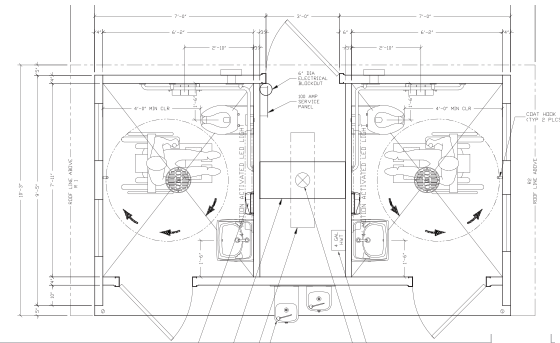

- A. Distances referenced here assume the front edge of a chair lines up with the edge of a table top.
- B. Allow a minimum of 36" between seat backs to permit wheelchair access between tables.
- C. Allow a minimum of 24" between seat backs to provide a walkway between tables.
- D. Allow a minimum of 18" between a seat back and a wall or edge to permit access to all seats.
- E. Allow a minimum of 60" between a seat back and a site's entrance to allow for easy egress.
- F. Please refer to ADA guidelines and local codes to determine the number of wheelchair accessible seating spaces needed in a seating group. It is recommended that a minimum of 32" in width be provided to accommodate a wheelchair at a table.
- G. The minimum height and depth clearances necessary to accommodate a wheelchair at a table are 27" and 19", respectively.

Universal Access

GUIDELINES FOR DESIGNING ADA COMPLIANT AND UNIVERSALLY ACCESSIBLE PARKS

MICHIGAN DNR GUIDELINES | [HTTPS://WWW.MICHIGAN.GOV/DOCUMENTS/DNR/UA-ADA_GUIDELINES_380528_7.PDF](https://www.michigan.gov/documents/dnr/ua-ada_guidelines_380528_7.pdf)

AMERICAN WITH DISABILITIES ACT (ADA)

Quick reference of minimum requirements for accessible spaces. The 2010 American with Disabilities Act Standards for Accessible Design Guidelines provide a comprehensive resource. https://www.ada.gov/2010ADASTandards_index.htm

- Clear width is 36" min for most accessible routes
- Surfaces: 1/4" max change, slopes less than 5%, firm and stable
- Head Clearance: 80" high and as wide as the route
- Clear Space: min 30" wide by 48" deep located at element
- Viewing: clear from 32"-51" height
- Maneuvering space: 60"x60" min and level, at entries and places for change of direction
- Transferable height: 17"-19" with transfer supports
- Knee Clearance: 27" high by 30" wide by 25" deep
- Table tops, counters, and rail heights: max 34" high
- Reach range: 48" max height forward and 15" min low side
- Operation: operating mechanism that is operable with one hand and does not require tight pinch/grasp/wrist twist to open

The following pages feature a closer look at each park within the City of Escanaba. Each has been assigned an accessible rating derived from this scale. The Michigan DNR Rating Chart is as follows:

- 1 | NONE OF THE FACILITIES MEET ACCESSIBILITY GUIDELINES
- 2 | SOME OF THE FACILITIES MEET ACCESSIBILITY GUIDELINES
- 3 | MOST OF THE FACILITIES MEET ACCESSIBILITY GUIDELINES
- 4 | THE ENTIRE PARK AREAS MEET ACCESSIBILITY GUIDELINES
- 5 | THE ENTIRE PARK WAS DEVELOPED USING UNIVERSAL DESIGN PRINCIPLES

Escanaba Access

A CLOSER LOOK AT THE ACCESSIBILITY OF PARKS WITHIN THE CITY OF ESCANABA



AL NESS + LEMERAND COMPLEX: 2

The Lemerand Complex features an accessible over 6' wide asphalt path, accessible restrooms, accessible stadium seating. The remainder of the park including Al Ness baseball field, parking, and play area are not accessible as maintained hard surface pathways to the various amenities are not available.



TAPANI FIELD + VETERAN'S PARK: 1

This site contains no accessible features. The street side parking, inaccessible field, playground, tennis courts, horseshoe area, picnic tables and basketball are all surrounded by lawn without accessible connections. This park has been identified as a top priority for updating. The addition of an accessible play space, accessible pathways throughout, and accessible picnic areas would prove excellent upgrades for all.



WEST-SIDE TRAILS: 1

This soft surface trail network and parking area are not accessible due to surfacing, steep grades, and an inaccessible port-a-john. Adding a consistent compacted gravel surface to the parking and trailhead area along with an even graded trail loop would allow for those with mobility issues to enjoy the site as well.



STEPHENSON PARK: 1

This park hosts a small play area, picnic area, and basketball court. All amenities are inaccessible as they do not offer a hard surface path or accessible parking. As with many of the other Escanaba sites. A continuous accessible pathway system would provide a much more inclusive park facility.

A CLOSER LOOK AT THE ACCESSIBILITY OF PARKS WITHIN THE CITY OF ESCANABA



LUDINGTON PARK: 3

An expansive park, Ludington hosts many accessible features. There is accessible parking in the marina (3 ADA for 70 spaces), near the band shell (4 ADA for 99 spaces), and on Aronson island (3 ADA for 78 spaces). One additional accessible space is required at the Aronson Island lot. There is a minimum 6' wide paved walking trail connecting nearly all facilities within the park including the fountain, interpretive signage, playground and gazebo. Recently, accessible drinking fountains have been added as well as some accessible play features. The restrooms and band shell seating also meet ADA requirements. A wooden boardwalk is installed at grade down to the municipal beach, but the gaps between the wood slats are too great to be considered an accessible pathway. The playground area at Municipal Beach is also inaccessible due to the edging and material surface. The play structure does have a transfer platform and the concrete circulation on the island passes quite close by so it would not be hard to make the play space more inclusive. Picnic spaces need to be improved providing hard surface trails and accessible tables so everyone can utilize them.



WEBSTER PARK: 3

Webster offers 2 accessible parking spaces signed and striped in a lot with 3 spaces and paths to all facilities. The bath house and wading pool were closed when visited but both appear to be fully accessible.



WEST SIDE PLAYGROUND: 1

An 8' wide concrete path winds through this mini park yet none of the play features or picnic tables can be accessed due to a lack of hard surface access paths leading to them. In addition to hard surface paths to the various play features and surfacing upgrades, the benches on site require a 30x48" hard surface pad adjacent to them to allow for companion seating.



ROYCE PARK: 2

This all season park offers an accessible warming shelter, restrooms and refreshment facility. The courts have 4' wide concrete pathways almost around the entirety of their surface, but a few 4' strips of grass limit who can spectate. The play area and basketball court as well as picnic area are all inaccessible due to grass surrounding

A CLOSER LOOK AT THE ACCESSIBILITY OF PARKS WITHIN THE CITY OF ESCANABA

SYLVAN POINT PLAYGROUND: 1

None of this site is accessible from the street side parking to the inaccessible play area and benches. A hardened access path throughout the park with ADA parking would prove a good start to making this site more inclusive.

CATHERINE BONIFAS CIVIC CENTER: 4

The civic center is an indoor athletic and community activity facility. The building and physical access meet all accessibility guidelines from the ADA marked parking spaces to the curb cut with ramp and concrete walkway to the building with a traditional angled aluminum transition plate at the door.

BAY COLLEGE SOCCER FIELDS: 4

The soccer field complex features 5 accessible parking spaces with a lot total of 18. A concrete walk to the concession/picnic facility which is also accessible. A 6' wide compacted gravel trail loops around the fields to provide an accessible trail for those who wish to stay occupied while others are playing soccer.



ESCANABA MARKETPLACE: 4

This new project features an expansive pavilion with paved access on all sides. There is accessible parking, but it is not marked with the International Symbol of Accessibility. A small playground hosts a completely accessible system with an access ramp and accessible artificial turf surfacing throughout.



BESSE PARK: 5

This park is a prime example of an accessible park. There is an adequate number of ADA parking spaces (2 ADA for 22 total spaces), all picnic tables and water fountains are sited on a concrete surface with proper leg room and table height (see universal accessible design guidelines), The play area features a poured in place rubber surface with ramp access and transfer platform. A winding 6' wide concrete path connects all of the elements on the site.



A CLOSER LOOK AT THE ACCESSIBILITY OF PARKS WITHIN THE CITY OF ESCANABA

DICKSON FIELD: 1

Dickson Field is adjacent to the Catherine Bonifas Civic Center. Properly signed, ADA is available at the Bonifas lot, the park would require the addition of an accessible route from parking to field and accessible seating options. None of which are currently available.

DOG PARK: 1

The dog park is located along the entry road to the airport and hosts two fenced in areas surrounded by turf. There are no accessible amenities on site. This site would need accessible parking with an accessible route to the entrance of the park.

ROSE PARK: 1

Rose Park has off street parking that could accommodate ADA signage. There is also a 4' wide sidewalk running through and around the park. Adding a properly graded curb ramp would connect the already accessible features allowing this park to be more inclusive. The play structures are surrounded by mulch and edging that prevent them from being accessible via a wheelchair. The tennis court currently has a sidewalk along one edge and if widened, could accommodate accessible seating space. This site is on the schedule for receiving updates to its court and could be designed to provide improved access for all.



NORTH SHORE BOAT RAMP: 4

The expansive parking lot hosts 213 parking spaces with 8 designated as ADA parking spaces. There is a boardwalk with a flat grade and large fishing platform at the end featuring 50% of the railing at a height of 30in. The fish cleaning station and restrooms have paved access and are properly signed with the International Symbol of Accessibility. The restrooms were not unlocked at the time of observation. The docks are 4' wide and each feature a transition plate with a minimal slope to accommodate those with mobility issues. The docks could use edge protection to prevent wheels from running off. In addition there is not enough space on the dock itself for a person to turn around in a wheelchair (60" diameter).



PORTAGE BAY ACCESS: 1

This site is a simple trail to the water's edge at Portage Bay. It does not provide any accessible options. If the City does plan to make any improvements, an accessible compacted gravel trail with appropriate access to the water's edge would be recommended.

